

Dolphin

CPAP



User Manual

MD

Neonatal bubble CPAP

UDI

111720643880

Effective date: February 2022
Issue Number: 01 Version: 1.09EN
Issue Date: February 2022

www.mtts-asia.com

CE 2265

 **MTTS**

Contents

Company Information	04
Introduction	06
Device Description	08
Bubble CPAP Therapy	18
- Warnings (CPAP)	18
- Setup (CPAP)	20
- Operation (CPAP)	30
- Alarm System (CPAP)	36
- Reprocessing (CPAP)	39
- Maintenance (CPAP)	46
Pulse Oximetry Monitoring	50
- Warnings (Pulse Oximeter)	50
- Overview (Pulse Oximeter)	52
- Setup (Pulse Oximeter)	56
- Operation (Pulse Oximeter)	58
- Alarm System (Pulse Oximeter)	66
- Sensors & Patient Cables (Pulse Oximeter)	70
- Maintenance (Pulse Oximeter)	74
Specifications	76
Explanation of Symbols	81
Warranty Policy	82

Company Information



MEDICAL TECHNOLOGY TRANSFER AND SERVICES Co., LTD
House No. 26, Alley 41, An Duong Vuong Street, Tay Ho District, Hanoi City, Vietnam

Tel: +84 24 3766 6521
Fax: +84 24 3718 8050
Email: assistance@mtts-asia.com
www.mtts-asia.com

Logic s.r.l.
Via Antonio Pigafetta 1
34147 Trieste, Italy



The device, a CPAP or Continuous Positive Airway Pressure machine, is designed to help premature and sick newborns who cannot breathe well on their own. The Wellcome Trust assisted with funding for the Thrive Networks and its partner, Vietnam-based social enterprise MTTs, for early development and pilot studies to prepare the device for CE-mark approval. The Wellcome Trust is no longer involved with the project.

The results of the study that compares CPAP Machines With Reusable vs Disposable Circuits are available under following link:

<https://clinicaltrials.gov/ct2/show/record/NCT03121612>

Company Information



Possession or purchase of this device does not convey any express or implied license to use the device with unauthorized sensors or cables which could, alone or in combination with this device, fall within the scope of one or more of the patents relating to this device.*

www.masimo.com/patents.htm

*this information is relevant only to the devices using Masimo SET technology

Introduction

- ⚠ This user manual is intended for healthcare professionals.
- ⚠ The Dolphin CPAP is to be operated by qualified personnel only. This manual, accessory Directions for Use, all precautionary information, and specifications should be read before use.
- ⚠ Before its first use, the Dolphin CPAP must be cleaned and disinfected according to the *Reprocessing (CPAP)* section.

The Dolphin CPAP includes both bubble CPAP therapy and pulse oximetry monitoring, making it ideal for providing respiratory support to spontaneously breathing neonates.



Introduction

Bubble CPAP Therapy

The Dolphin CPAP provides precisely blended, heated and humidified gas to the patient according to input flow rate, FiO_2 and pressure settings. Flow rate and FiO_2 are easily adjusted by pressing the arrows on the CPAP display. Pressure is set by moving the column to the desired underwater depth in the PEEP chamber. The humidifier and heated breathing circuit work together to deliver optimally heated and humidified gas with minimal rainout.

Pulse Oximetry Monitoring

The Dolphin CPAP incorporates the selection of MTTS Pulse Oximeter module and Masimo SET® technology to provide accurate, reliable and robust monitoring of a patient's pulse rate and functional oxygen saturation of arterial hemoglobin (SpO_2). An easy-to-configure physiological alarm system is included to notify staff in the event that measured vital signs fall outside of their target ranges.

Indications for use

The Bubble CPAP Therapy provided by the device is indicated for the respiratory support of spontaneously breathing neonatal patients with mild to severe idiopathic respiratory distress syndrome (RDS), mild to severe apnea, atelectasis, hyaline membrane disease (HMD), meconium aspiration syndrome (MAS), transient tachypnea of the neonate (TTN) or lung edema. The device is indicated for use in a hospital setting. The device is not indicated for use with patients whose upper airways have been bypassed.

The Pulse Oximetry Monitoring provided by the device is indicated for the continuous, non-invasive monitoring of functional oxygen saturation of arterial hemoglobin (SpO_2). The device and its accessories are indicated for use with neonatal patients during both motion and no motion conditions, who are well or poorly perfused patients in a hospital setting.

Device Description

Overview

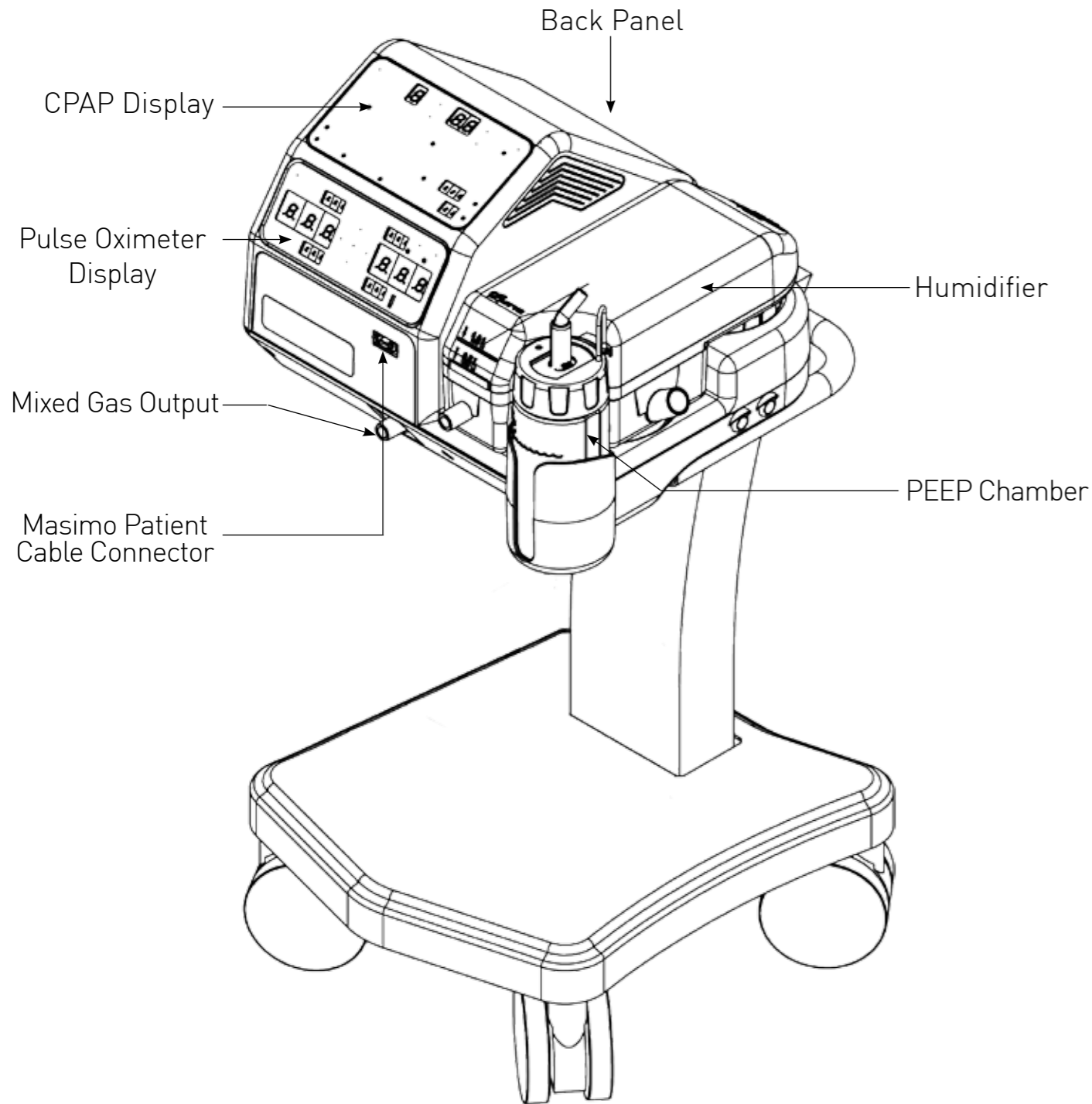

Device Description

Back Panel



1	12V UPS Connector	Use this connector to connect MTTs backup 12V power supply
2	AC Power Inlet	Use this power inlet to connect the device to mains power. The power requirements for the device are listed on the back panel and in the <i>Specifications</i> section.
3	Mains Power Switch	This switch is used to turn the mains power to the device on and off. The switch is pictured in the off position.
4	Oxygen Inlet	Use this CGA 1240 oxygen inlet to connect a compressed oxygen source to the device.

 Contact MTTs representative with specific questions about alternative power sources.

Device Description

CPAP Display

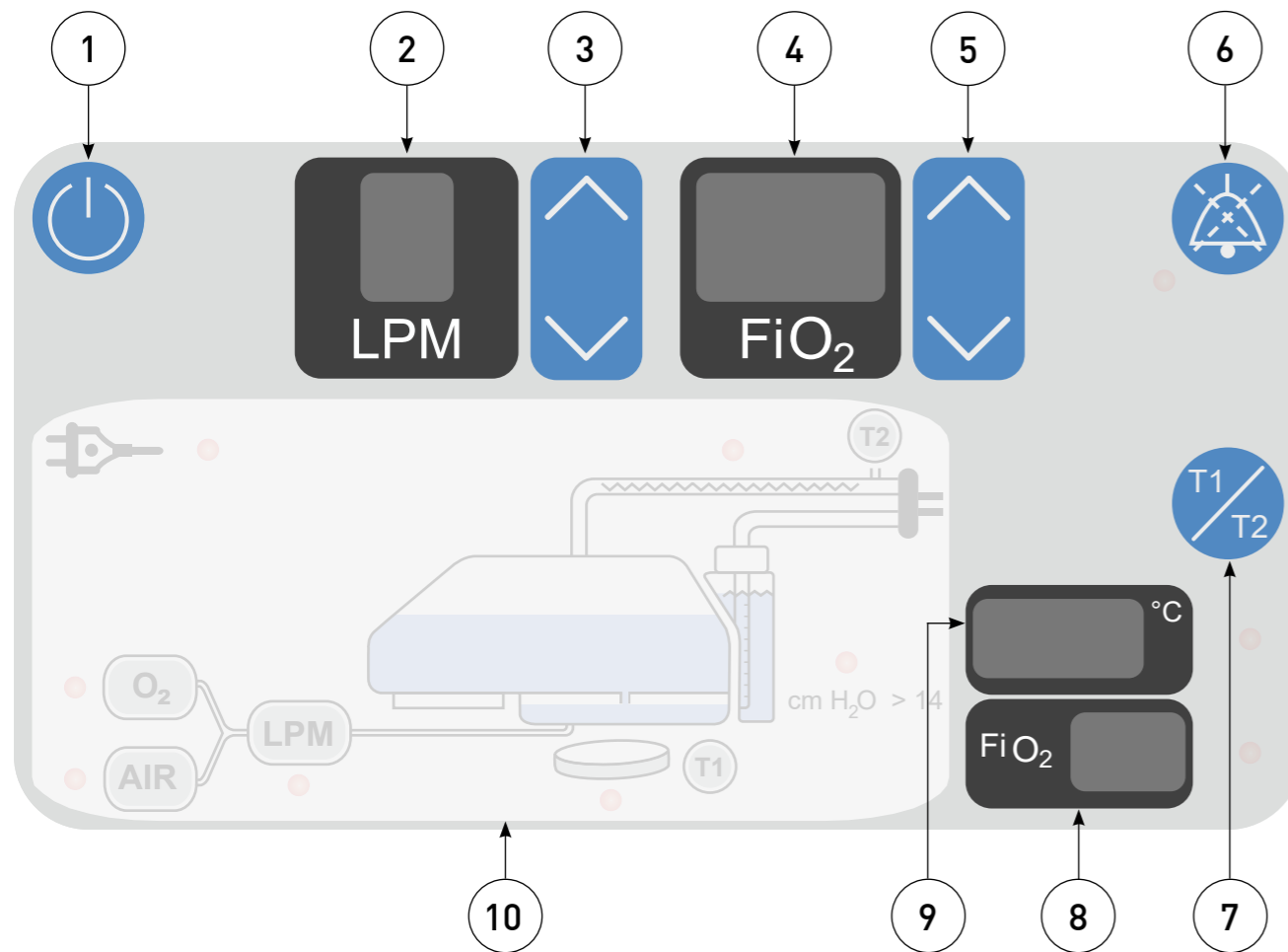

1	On / Off Button	Hold this button for 2 seconds to turn the CPAP display and functions on and off.
2	Set Flow Rate Display	Shows the selected flow rate of mixed gas in L/min.
3	Set Flow Rate Adjustment Arrows	Use these buttons to increase or decrease the selected flow rate.
4	Set FiO₂ Display	Shows the selected FiO ₂ as a percentage.
5	Set FiO₂ Adjustment Arrows	Use these buttons to increase or decrease the FiO ₂ percentage.

Device Description

6	Alarm Silence Button	Press this button to temporarily silence CPAP alarm sounds for 110 seconds. Press it again to restore alarm sounds.
7	Set Temperature Button	Set temperature button: See Operation (CPAP), step 4. <i>Adjust the humidifier and airway temperature set point</i>
8	Measured FiO₂ Display	Shows the FiO ₂ of the gas delivered to the patient.
9	Measured Temperature Display	Shows the lower of the measured temperatures (humidifier and airway) in °C. During warmup, the display flashes to indicate the device is not yet ready for use.
10	CPAP Alarm System	See the <i>Alarm System (CPAP)</i> section for detailed information about the CPAP alarm system.

Accessories

Dolphin CPAP set is provided with following accessories (one piece of each):

Part	Order Code	Component of
Humidifier	CPD-10800	Breathing Circuit
PEEP Chamber	CPD-10900	Breathing Circuit
Silicon Tube Set	CPD-11001	Breathing Circuit
Heater Wire Draw Line	CPD-11002	Breathing Circuit
Temperature sensor	CPD-11003	Breathing Circuit
Heater Wire Connector	CPD-11004	Breathing Circuit
Oxygen Sensor	CPD-11100	Control box
Inlet Gas Filter	CPD-11200	Control box
Cleaning Brush	CPD-11300	Reprocessing
Pulse ox Sensor	CPD-11400	Pulse ox

Device Description

Pulse Oximeter Display

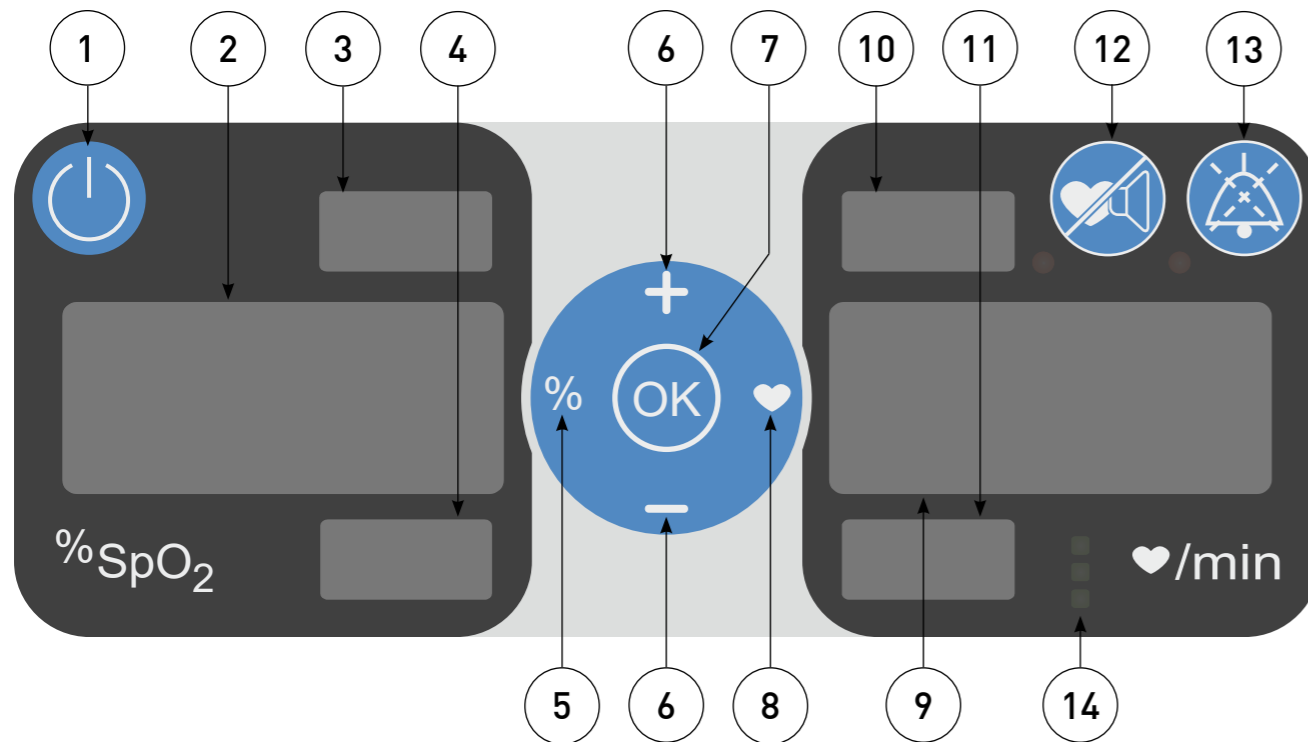

1	On / Off Button	Hold this button for 2 seconds to turn the Pulse Oximeter display and functions on and off.
2	Saturation Display	Shows the functional oxygen saturation of arterial hemoglobin in units of SpO ₂ . When searching for a signal, this display will flash dashed lines.
3	Saturation Upper Alarm Limit	Shows the upper alarm limit for saturation. When flashing, this alarm limit can be adjusted using the Increase / Decrease Buttons.
4	Saturation Lower Alarm Limit	Shows the lower alarm limit for saturation. When flashing, this alarm limit can be adjusted using the Increase / Decrease Buttons.
5	Saturation Alarm Limit Adjustment Button	Press this button once and the Saturation Upper Alarm Limit will start flashing. Once flashing, the alarm limit can be adjusted using the Increase / Decrease Buttons.

Device Description

6	Increase / Decrease Buttons	Use these buttons to adjust the alarm limits when they are flashing. Press and hold the buttons for faster adjustment.
7	OK / Select Button	Press this button after adjusting an alarm limit to save the new alarm limit. If you press this button while an upper alarm limit is flashing, the lower alarm limit will start flashing.
8	Pulse Rate Alarm Limit Adjustment Button	Press this button once and the Pulse Rate Upper Alarm Limit will start flashing. Once flashing, the alarm limit can be adjusted using the Increase / Decrease Buttons.
9	Pulse Rate Display	Shows pulse rate in beats per minute (bpm). When searching for a signal, this display will flash dashed lines.
10	Pulse Rate Upper Alarm Limit	Shows the upper alarm limit for pulse rate. When flashing, this alarm limit can be adjusted using the Increase / Decrease Buttons.
11	Pulse Rate Lower Alarm Limit	Shows the lower alarm limit for pulse rate. When flashing, this alarm limit can be adjusted using the Increase / Decrease Buttons.
12	Pulse Sound Silence Button	Press this button to silence the pulse sound indefinitely. Press this button again to resume playing the pulse sound.
13	Alarm Silence Button	Press this button to temporarily silence Pulse Oximeter alarm sounds for 110 seconds. Press it again to restore alarm sounds.
14	Perfusion Indicator	Displays perfusion index (the ratio of the pulsatile blood flow to the nonpulsatile or static blood in peripheral tissue). If perfusion index is high, all of the green lights will rise and fall in correspondence with the pulse. If the perfusion index is lower, two green lights will rise and fall with the pulse. If the perfusion index is very low, a red light will flash with the pulse.

Device Description

Humidifier

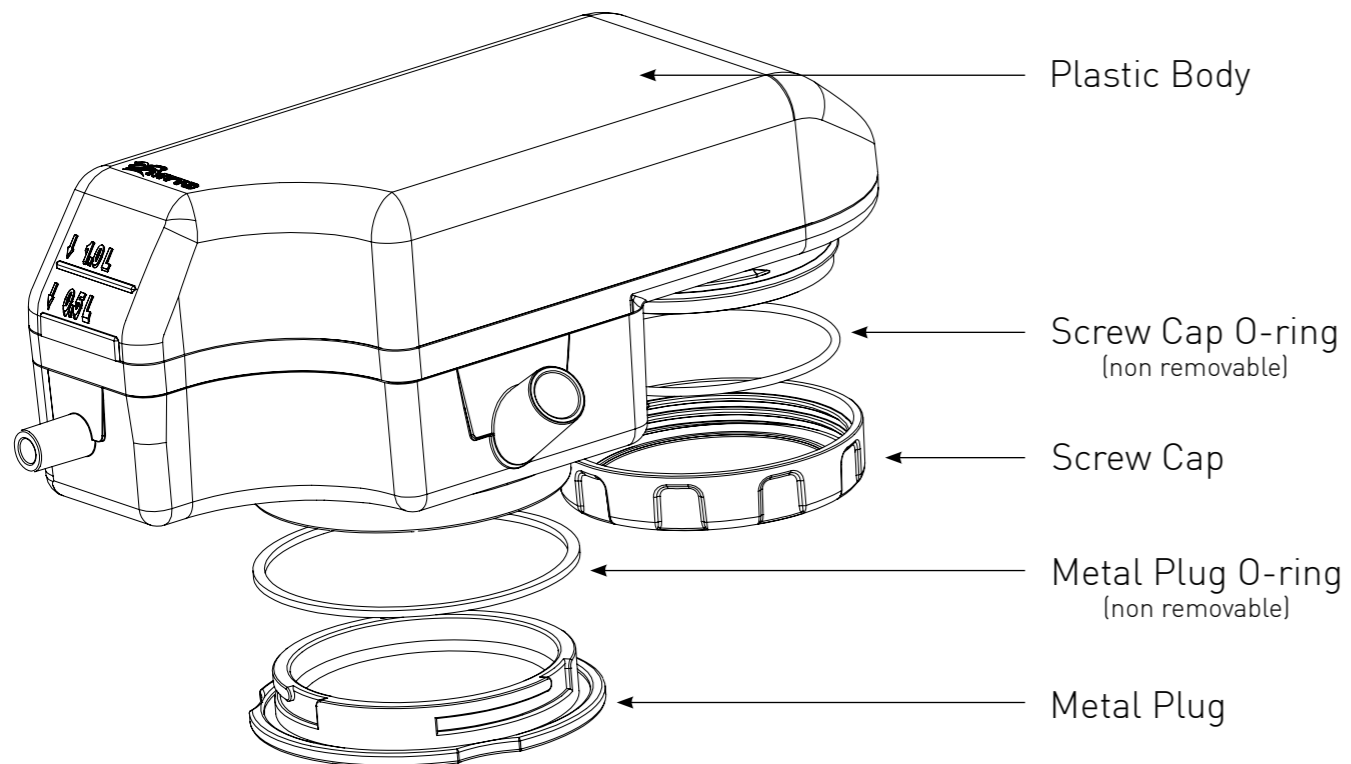
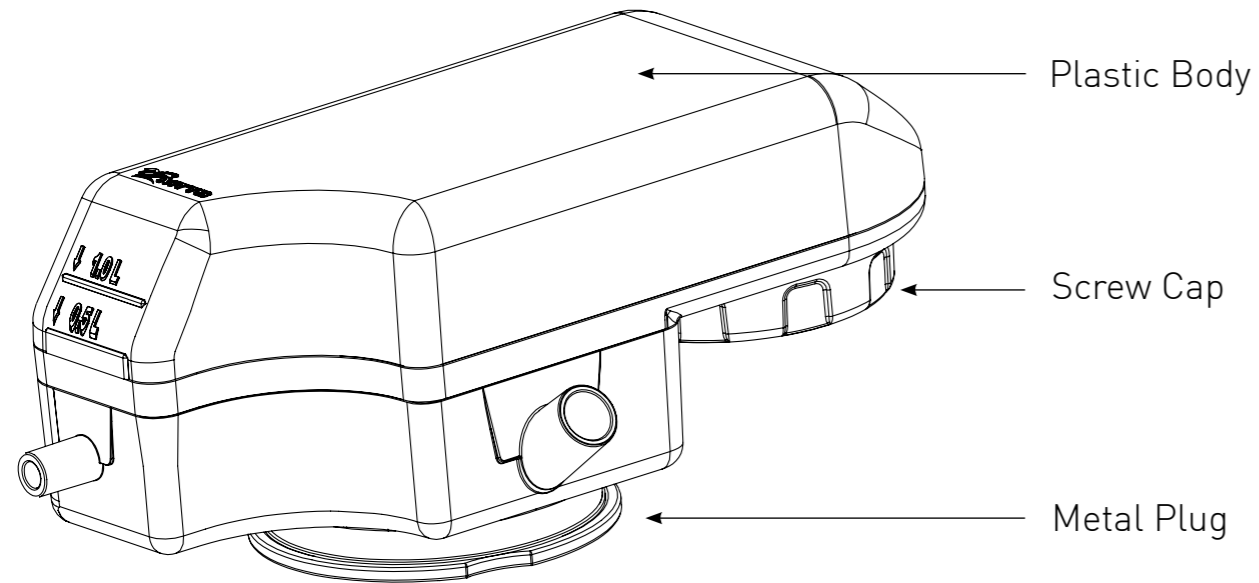

Device Description

Breathing Circuit

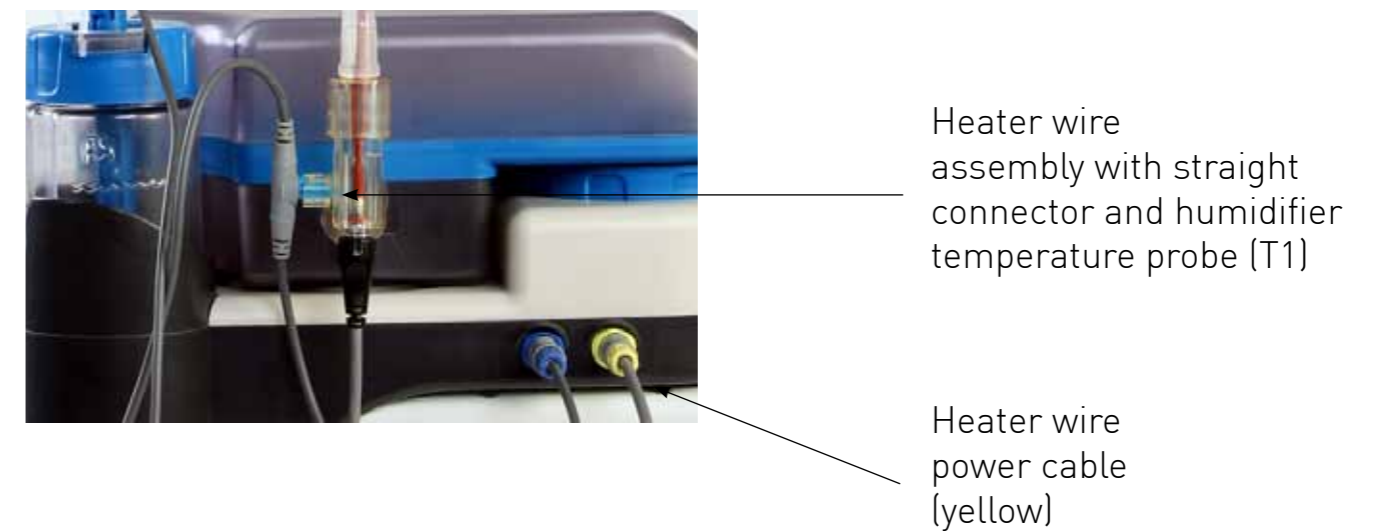
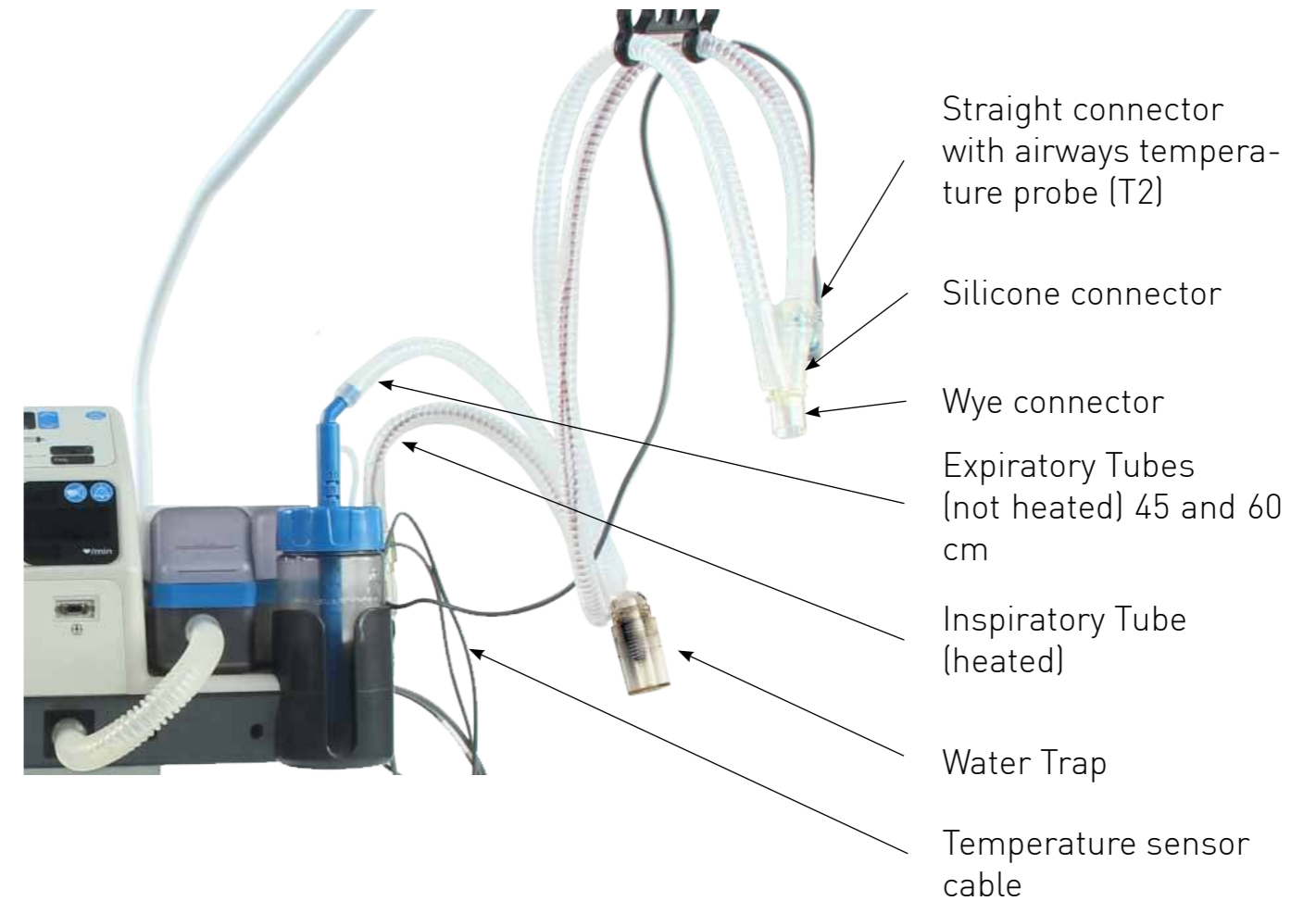

Device Description

PEEP Chamber

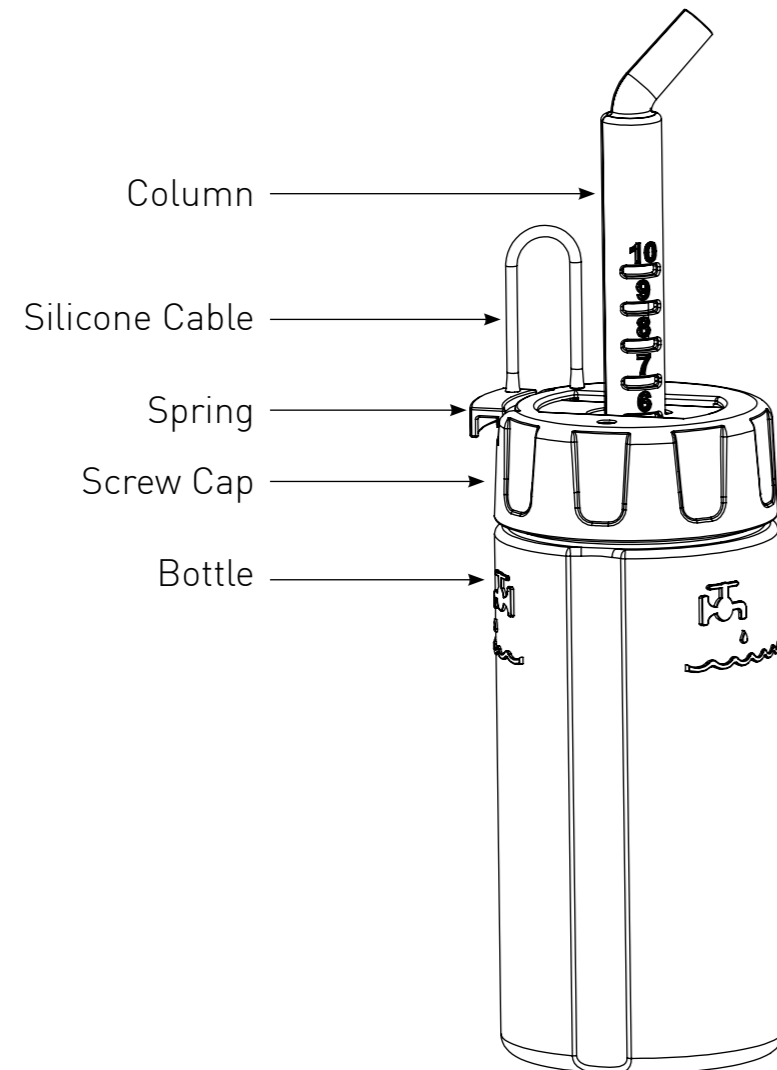

i PEEP Chamber can be used safely and effectively without the Silicone Cable, which is only used to ensure that the Spring is not lost





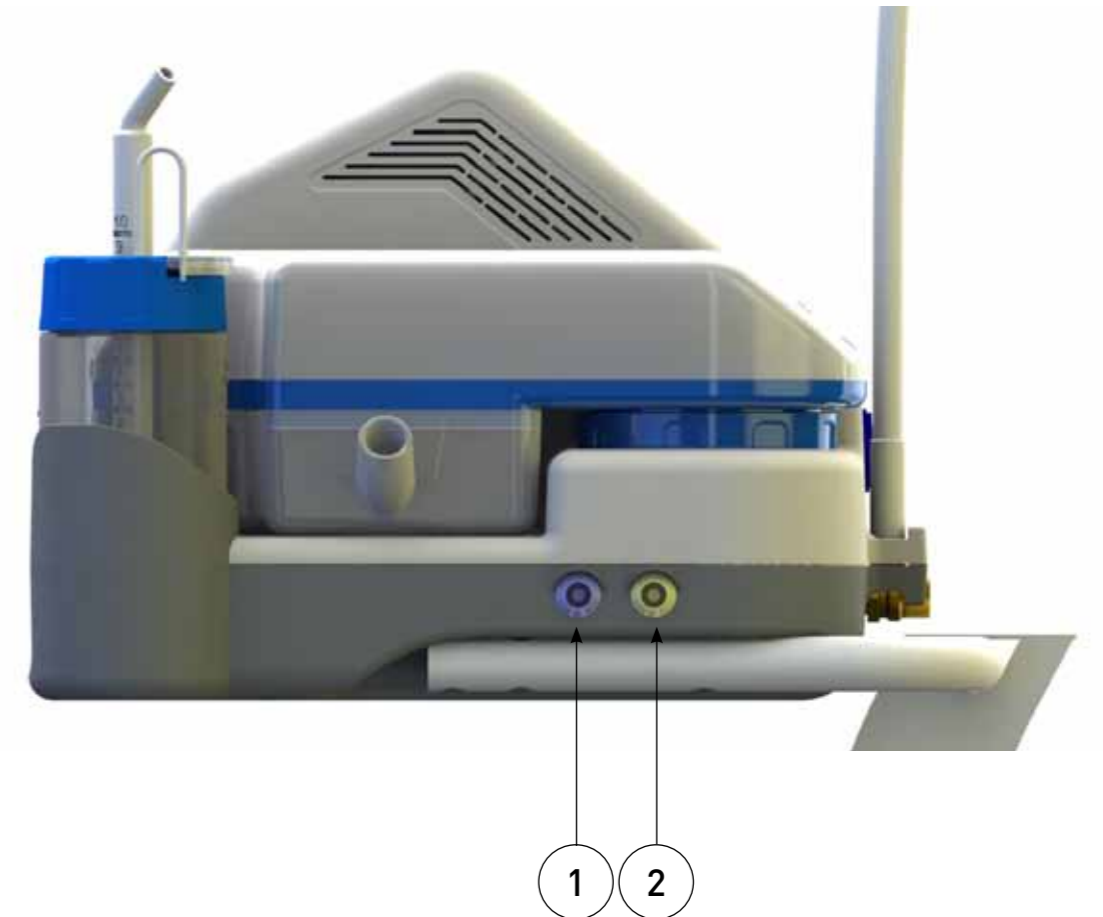





Device Description

Side Panel





1	Temperature Probe Cable Connector (6-pin)
2	Heater Wire Power Cable Connector (4-pin)

Warnings (CPAP)

-  The Dolphin CPAP is to be operated by qualified personnel only. This manual, accessory Directions for Use, all precautionary information, and specifications should be read before use.
-  Explosion hazard. Do not use the Dolphin CPAP in the presence of flammable anesthetics or other flammable substance in combination with air, oxygen-enriched environments, or nitrous oxide.
-  Electrical shock hazard. An operator may only perform maintenance procedures specifically described in this manual. If further maintenance is required, contact your MTTs representative to repair this equipment.
-  Do not modify this equipment without authorization of the manufacturer.
-  Using the device outside of the specified ambient temperature range (19°C to 37°C) or humidity range (30%RH to 90%RH) can compromise performance.
-  Do not operate the device if any of the components appear to be damaged or broken. Damaged or broken components should be discarded and replaced.
-  Do not position the device in a location that reduces its ventilation.
-  Do not block any of the air vents on the sides or bottom of the device.
-  The presence of electro-surgical devices, shortwave or microwave equipment near this device could lead to electrical interference that would negatively affect the function of the device.
-  Before its first use, the device must be cleaned and disinfected according to the *Reprocessing (CPAP)* section. The device must be cleaned and disinfected according to this section before each use with a new patient.
-  Using the humidifier, PEEP chamber, tubing or other breathing circuit components without cleaning or disinfection between patients can result in infections.

Warnings (CPAP)

-  The device should only be used with the humidifier, PEEP chamber, tubing, cables and connectors specified in this user manual. Use of components not specified in this user manual can result in serious injury to the patient or operator or damage to the device.
-  Adding heat to the patient circuit above ambient temperature levels could result in higher condensation in the inspiratory tube. This includes heat added through incubators, overhead warmers or blankets covering some part of the heated patient circuit.

Setup (CPAP)

1. Assemble and fill the humidifier.

 Ensure the metal plug o-ring and the screw cap o-ring are both present. The humidifier cannot be used without these o-rings.

A. Attach the metal plug by sliding it on to the bottom of the humidification chamber and twisting to engage the locking mechanism.



B. Place the humidifier upside down on a table, countertop or other flat surface. Use distilled or sterile water to fill the humidifier through the screw cap hole.

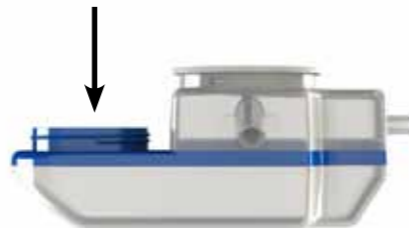

 The fill lines indicate the amount of water that will be available for therapy once the humidifier is flipped right-side up.

Setup (CPAP)

C. Attach the screw cap by twisting it onto the threads until a tight seal is formed.



D. Place the humidifier right-side up on a flat surface. Wait 1 minute and observe if water is leaking from either the metal plug or the screw cap.



E. If no leaks are observed, carefully carry the humidifier to the control box and place it so the metal plug sits flat on the heater plate.

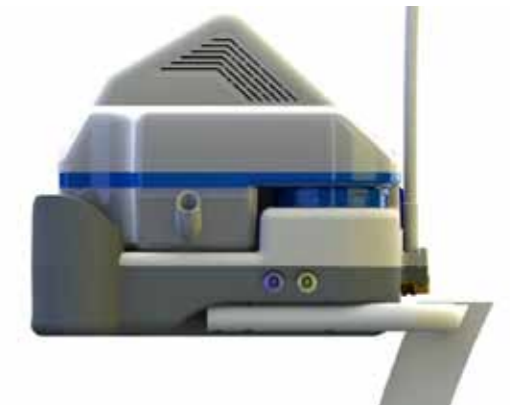

 If leaking occurs, check that the parts are correctly assembled and not damaged. Discard and replace any damaged parts.

Setup (CPAP)

2. Assemble and fill the PEEP Chamber.

A. Fill the bottle with distilled or sterile water until the water level reaches the fill line.



B. Attach the screw cap by twisting it until tight.



C. Insert the spring into the screw cap in the orientation shown in the picture.



Setup (CPAP)

D. Line up the notch in the column with the plastic extension of the spring. Press in the spring and begin to insert the column into the bottle. When the numbers on the column reach the cap, you will need to twist the column back-and-forth to continue inserting it. Once you have reached the desired depth, release the spring to lock the column in place.



i The numbers on the column indicate the depth of the column (in cm) in the water when the water is filled up to the fill line.

E. Place the assembled PEEP Chamber in the PEEP Chamber holder.



Setup (CPAP)

3. Assemble the heated breathing circuit.

A. Prepare the draw line for this procedure

 Make sure the draw line is clean before using it. You should disinfect it with alcohol based solution.



B. Push the heater wire from the wide side of the straight connector through to the other side.



C. Pull the straight connector down the wire until it reaches the heater wire housing. Firmly connect the two plastic parts.



Setup (CPAP)

D. Insert the draw line into the inspiratory breathing tube until the narrower end extends outside of the tube. Hook this end around the heater wire.



E. Gently pull the wire into the breathing tube. Continue pulling until the breathing tube can be attached to the straight connector. Attach the tube firmly. Once attached, twist the draw line slightly to detach it from the heater wire. Pull the draw line completely out of the tube and set it aside.



F. Attach water trap between expiratory breathing tubes (the order of the tubes is not important)



G. Attach the straight connector with temperature probe port to the end of the inspiratory tube (the direction of this part is not important). Then attach the silicone connector, wye connector, and expiratory breathing tube as shown in the pictures.



Setup (CPAP)

4. Attach the heated breathing circuit.

A. Attach the heater wire housing to the humidifier. The heater wire housing should point straight up, as shown in the picture.



B. Attach the expiratory tube to the PEEP column.

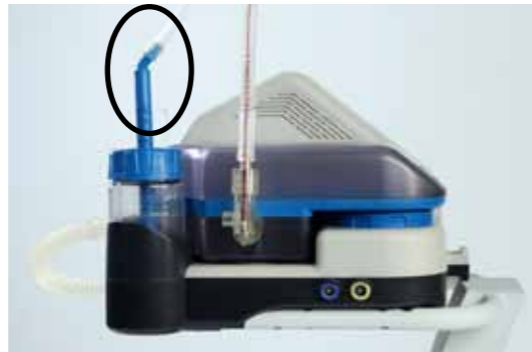

C. Attach the yellow plug of the heater wire power cable to the yellow female connector on the device.

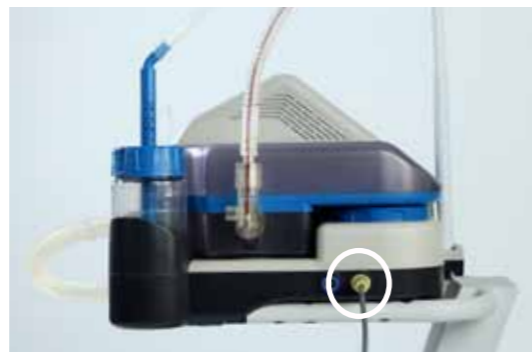

Setup (CPAP)

D. Attach the black end of the heater wire power cable to the heater wire connector.

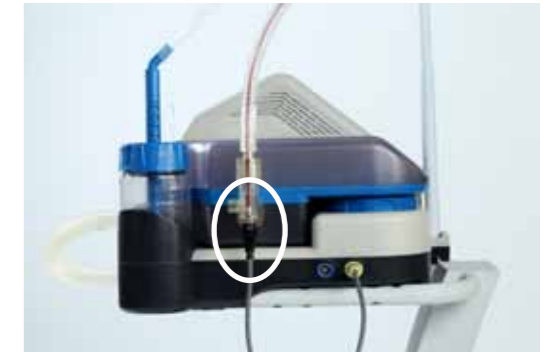

E. Attach the blue plug of the temperature sensor cable to the blue female connector on the device.

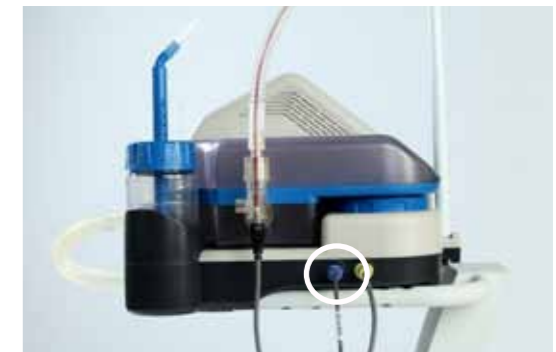

F. Attach temperature probe T1 to the port in heater wire housing (white circle) and T2 to port in the straight connector (black circle).

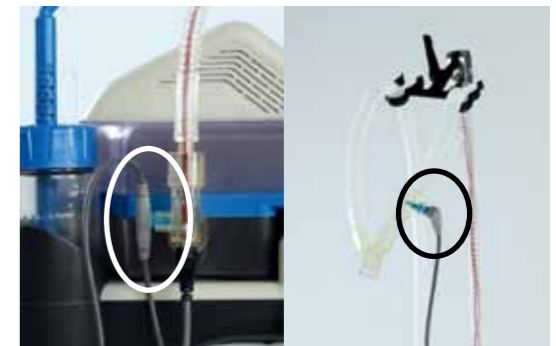

 Make sure the temperature probes are fully inserted. If they are not, it could result in a burn to the patient due to increased inspiratory gas temperature.

Setup (CPAP)

5. Attach the humidifier connection tube, gas hose, and power cord.

A. Attach the humidifier connection tube to the humidifier gas inlet and the mixed gas output on the control box.



B. Attach the compressed oxygen source to the CGA 1240 oxygen inlet.



! Do not attach the device to the humidifier bottle often provided with the flow meter. Attach it directly to the flow meter or pressure gauge. The humidification of the oxygen is not necessary at this stage and can increase the risk of damaging the device by condensing water.

i The gas sources must provide pressure within the range of 10 to 60 psi (0.7 to 4.1 bar). If the gas sources are outside of this range, the device may not be able to produce the desired flow rate and %FiO₂.

i Attaching the compressed oxygen will not waste any oxygen. The machine will not use any compressed oxygen until you increase the FiO₂ value in step 3 in the *Operation (CPAP)* section.

Setup (CPAP)

C. Attach the power cord to the AC power inlet on the back of the Dolphin CPAP.

D. Locate an AC power source with adequate power rating for the Dolphin CPAP. The power requirements for the device are listed on the back panel and in the *Specifications* section.

E. Connect the power cord to the appropriate AC power source.

! Only connect the Dolphin CPAP to a three-wire, grounded, hospital-grade receptacle. The three-conductor plug must be inserted into a properly wired three-wire receptacle; if a three-wire receptacle is not available, a qualified electrician must install one in accordance with the governing electrical code.

! Do not under any circumstances remove the grounding conductor from the power plug.

! Do not use extension cords or adapters of any type. The power cord and plug must be intact and undamaged.

! To ensure patient electrical isolation, connect only to other equipment with electronically isolated circuits.

! Do not connect the Dolphin CPAP to an electrical outlet controlled by a wall switch or dimmer.

Operation (CPAP)

1. Turn on power to the CPAP.

- A. Move the rocker switch to the on position and wait 3 seconds.



- B. Press and hold the power button on the CPAP Display for 2 seconds.

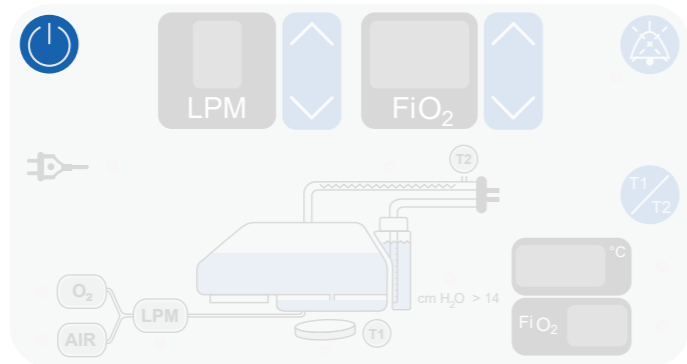

- C. After turning on the CPAP display, all of the lights will turn on and an alarm tone will sound briefly

i If a system failure is detected by the Dolphin CPAP at this time, an error message will be indicated by the letter 'E' and a number on the display. If this happens, note the error number and contact your MTTS representative.

Operation (CPAP)

2. Allow the CPAP to warm-up (≤10 minutes).

! Do not connect the patient to the device during warm-up. If you do, the patient will receive inspiratory gas with suboptimal temperature and humidity.

No action is required during this step. When the displayed temperature value stops flashing, you may proceed to the next step. The bullet points below describe what the Dolphin CPAP is doing during this time.

- The heater plate and wire begin heating.
- The gas begins flowing at 6 L/min and 21 %FiO₂.
- The temperature display flashes and the red light next to the temperature display is illuminated until warm-up is complete.

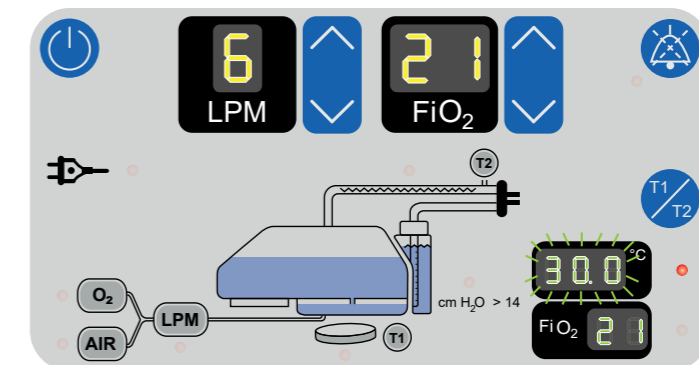

- The warm-up is complete when the temperature display value stops flashing and the red light turns off.

i The temperature display will typically show the lower of the measured humidifier and airway temperatures in °C. Step 8 explains how you can choose to view the humidifier temperature or the airway temperature.

i The default temperature for the humidifier temperature sensor (T1) is 34°C. The default temperature for the airway temperature sensor (T2) is 37°C.

i Ambient conditions can cause excessive condensation in breathing circuit. This effect can be reduced by adjusting T1 and T2 temperatures - see step 4.

Operation (CPAP)

3. Adjust the target flow and FiO₂ set points.

- A. Adjust the Set Flow Rate using the arrow keys next to the Set Flow Rate Display.

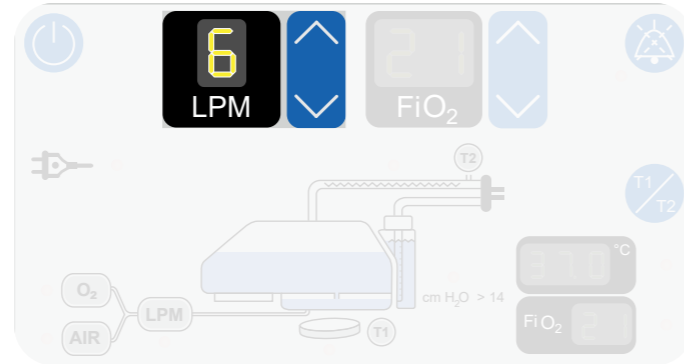

- B. Adjust the Set FiO₂ using the arrow keys next to the Set FiO₂ Display.

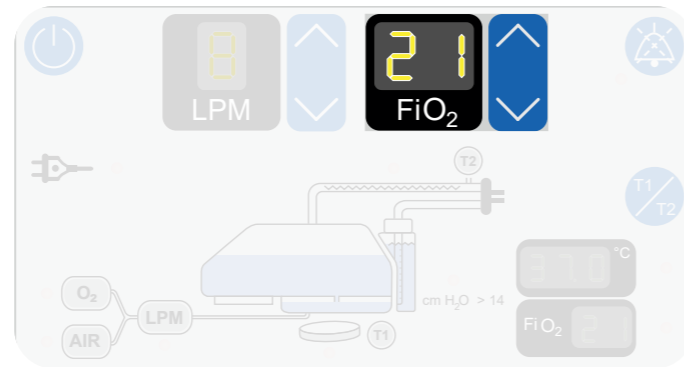

4. Adjust the humidifier and airway temperature set point.

- A. Press Set temperature button (T1/T2 button). The temperature display will flash during adjustment.

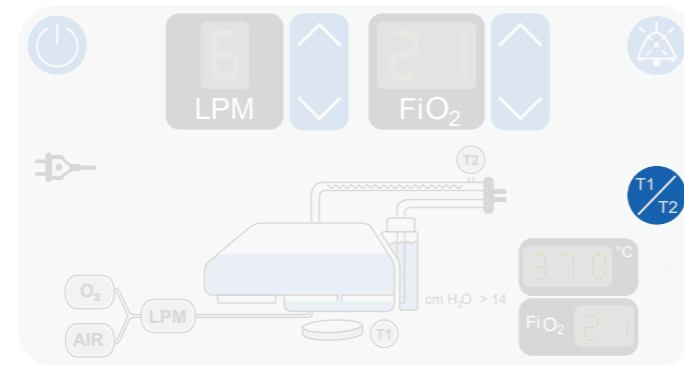

- B. Use either set of arrows to adjust T1 set point (31°C-37°C). Confirm by pressing the T1/T2 button again.

- C. Use either set of arrows to adjust T2 set point (35°C-40°C). Confirm by pressing the T1/T2 button again.

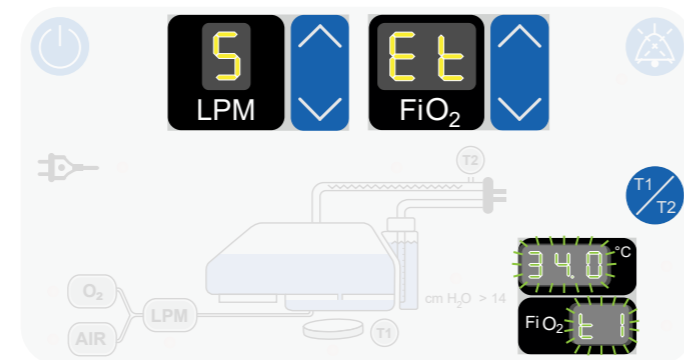

Operation (CPAP)

5. Adjust the PEEP column to the target pressure.

Press in the PEEP spring with one hand, and use the other hand to twist the column back-and-forth while pulling it up or pushing it down. Once the column is at the desired depth, release the spring to lock it in place. Refer to the *Specifications* section for information about the relationship between the PEEP column setting, delivered pressure, and flow rate.

6. Test for leaks.

Occlude the opening on the patient interface connector with your palm (covered in a sterile glove) and observe for bubbling in the PEEP chamber. If there is bubbling, proceed to the next step. If there is no bubbling, look for any leaks in the breathing circuit. If no leak is found, increase the flow rate by 1 L/min and recheck.

7. Connect to the patient.

- A. Select an appropriate patient interface for the patient according to hospital protocol. Make sure it can attach to the 15mm conical connector on the breathing circuit, but do not attach it.

- B. Apply the patient interface to the patient according to hospital protocol.

- C. Connect the patient interface to the breathing circuit.

- D. There should be bubbling in the PEEP chamber. If there is no bubbling, check for leaks in the breathing circuit.

8. Monitor during use.

- A. Check that the water in the PEEP chamber remains at the fill line. If the water drops below the fill line, carefully add more water through the syringe fill hole.

- B. Check for condensation in the breathing circuit. Drain the water trap as required.

- C. Check the water level in the top of the humidifier. When it gets below the level of the blue plastic trim, refill it or replace it with a new humidifier, in line with local policy. If replacing, clean and disinfect the used humidifier according to the *Reprocessing (CPAP)* section.

Operation (CPAP)

- D.** Ensure the water in the PEEP chamber is bubbling. If it is not bubbling and there is an alarm signalling on the display, address the alarm using the *Alarm System (CPAP)* section as guidance. If it is not bubbling and there is no alarm on the display, disconnect the patient from the breathing circuit and occlude the patient interface with your palm (covered in a sterile glove). If bubbling resumes, check patient for apnea or air leakage from the mouth. If bubbling does not resume, there is likely a leak in the breathing circuit.
- E.** The temperature display typically displays the lower of the measured humidifier and airway temperatures. To check the temperature at both sensors, hold down the alarm silence button for 2 seconds. After 2 seconds, the temperature display will show the humidifier temperature and the FiO₂ display will show the text "t1". After a few seconds, the temperature display will show the airway temperature and the FiO₂ display will show the text "t2".

9. Turn off the CPAP.

- A.** When you are done using the CPAP, turn it off by pressing and holding the power button for 2 seconds.

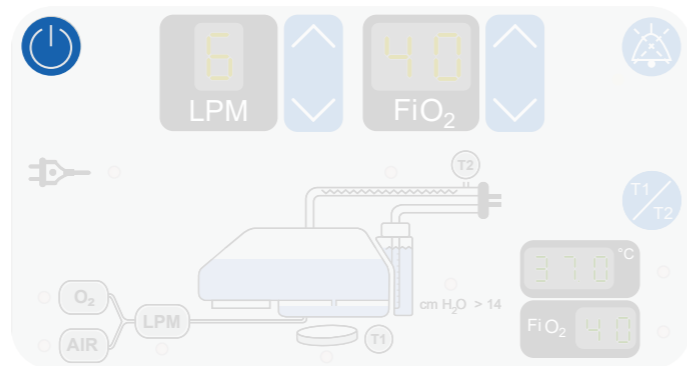

- B.** After pressing the power button, move the rocker switch to the off position.



 The Dolphin CPAP must be reprocessed between uses with different patients. Reprocess the Dolphin CPAP according to the *Reprocessing (CPAP)* section.

Alarm System (CPAP)

 The Pulse Oximeter has a separate alarm system explained in the *Alarm System (Pulse Oximeter)* section.

The CPAP alarm system will generate visual and audible alarm signals to notify you of alarm conditions that the system detects.

1. Alarm Identification

Each alarm condition in the CPAP alarm system is considered a high priority alarm. Each alarm includes both an audible and visual alarm signal. It is best that the operator be within a maximum of 1 meter from the unit to observe the alarms.

2. Alarm Indication

An alarm condition is indicated by:

- Audible alarm tone
- Visual alarm indicator (1 flashing red light)





3. Alarm Silence

Audible alarms may be suspended, while visual alarms may not. The alarm silence button is used to temporarily silence audible alarms for 110 seconds. When this button is pressed, a yellow light is illuminated next to the button and audible alarms are silenced. When the button is pressed and the yellow light is already on, the yellow light turns off and alarm sounds are restored.



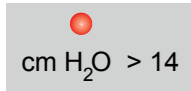
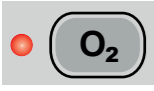

Symbol	Description
	Press this button to temporarily silence CPAP alarm sounds for 110 seconds. Press it again to restore alarm sounds.

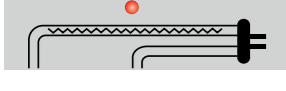
Alarm System (CPAP)

4. Alarm Signals

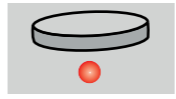
Symbol	Description	Solution
	The machine has detected a system failure and has shut itself down.	Turn the machine off and then on again. If the error message is still present, note the error number and contact your MTTs representative.
	The machine has been disconnected from the mains power supply.	(1) Check that the power cable is connected to the machine and the wall. (2) Check that the rocker switch on the back panel is in the ON position. (3) Check that the mains power supply is within the required power range for the machine.
	The pressure at the patient interface is >14 cmH ₂ O.	(1) Check that there are no kinks or compressions of the breathing tubes. (2) Check that the water level in the PEEP chamber is at the fill line. (3) If the alarm continues contact your MTTs representative.
	The input pressure for oxygen is too low (<10 psi) or too high (>60 psi).	(1) Check that the compressed oxygen tank is connected to the machine. (2) If the tank is low on oxygen, replace it. (3) If the alarm continues contact your nearest MTTs representative.
	The input pressure for air is too low.	(1) Replace air filter. See the <i>Maintenance (CPAP)</i> section for details.
	The heater wire has been disconnected or damaged.	(1) Check that the heater wire power and temperature sensor cables are plugged in securely at both ends. (2) Check that the heater wire is not damaged.

Alarm System (CPAP)

Symbol	Description	Solution
	The heater plate has overheated and turned itself off momentarily.	(1) Check that the humidifier reservoir contains water and that the humidifier is sitting flat on the heater plate. (2) If the reservoir contains water, there may be a problem with the refill mechanism. To force the refill mechanism to work, disconnect the patient and briefly occlude the inspiratory circuit.
	The actual temperature of T1 or T2 is not within $\pm 2^{\circ}\text{C}$ of the set point.	(1) Check that the heater wire power and temperature sensor cables are connected at both ends. (2) Make sure the temperature sensors are completely inserted. If the sensors are loose, they may be inaccurate. (3) Check that there are no leaks in the breathing circuit. (4) Check that no external heat source is heating the patient circuit.
	The measured FiO ₂ average over the past 30 seconds is not within $\pm 10\%$ FiO ₂ of the set value. This alarm cannot activate for the 30 seconds following a change to input flow rate or FiO ₂ .	(1) If the alarm light for air or oxygen input pressure is on, troubleshoot that alarm first. (2) Verify that O ₂ source is over 90% (3) Recalibrate or replace the oxygen sensor. See the <i>Maintenance (CPAP)</i> section for details. (4) After all steps, if measured FiO ₂ is still higher than set FiO ₂ , contact MTTs
	The measured flow rate average over the past 10 seconds is ± 0.5 L/min different than the set flow rate. This alarm cannot activate for the 10 seconds following a change to input flow rate or FiO ₂ .	(1) Check expiratory tube for condensation rain-out. Drain it out if needed. (2) If any other alarm light is on, troubleshoot that alarm first. (3) Turn the machine off and on again. If an error message is present, note the error number and contact your MTTs representative.

Alarm System (CPAP)

3. CPAP Alarm system test

The functionality of the alarm system can be verified at any time that the CPAP display is on. To verify the alarm system is functioning correctly, unplug the heater wire cable from the side of the machine. An alarm should sound and a flashing red light should be visible next to the heater wire image on the CPAP display. If either of these things does not happen, do not use the machine and contact your MTTs representative.

Reprocessing (CPAP)

The Dolphin CPAP must be reprocessed between uses with different patients. The reprocessing steps should be carried out as soon as possible after using the device. Most of the parts can be reprocessed at the same time according to the following steps:

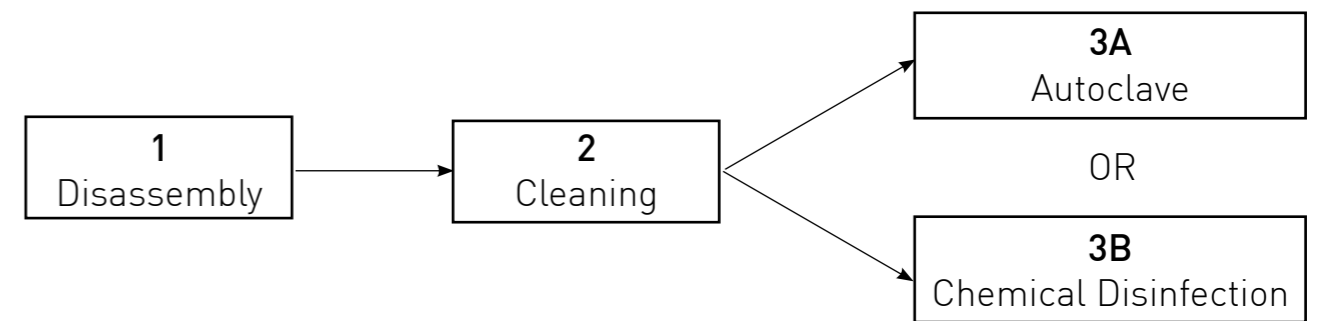

The temperature sensor cable must be reprocessed separately according to step 4 in this section.

- i** The disinfection processes in steps 3B and 4 have been tested with the Dolphin CPAP. If you do not have the products recommended for these processes, you may use alternative disinfection agents as long as they can achieve high-level disinfection and are compatible with silicone, polysulfone, and aluminium. Contact your MTTs representative with specific questions about alternative disinfection methods.
- i** At the time of this publication, bleach solution is not an FDA approved high-level disinfectant.

! Make sure to wash your hands and/or wear sterile gloves when reassembling breathing circuit.

Reprocessing (CPAP)

1. Disassembly

Disassemble all parts of the breathing circuit, PEEP chamber, and humidifier. Separate the parts according to the picture.

Process using steps 2 and 3A/3B.

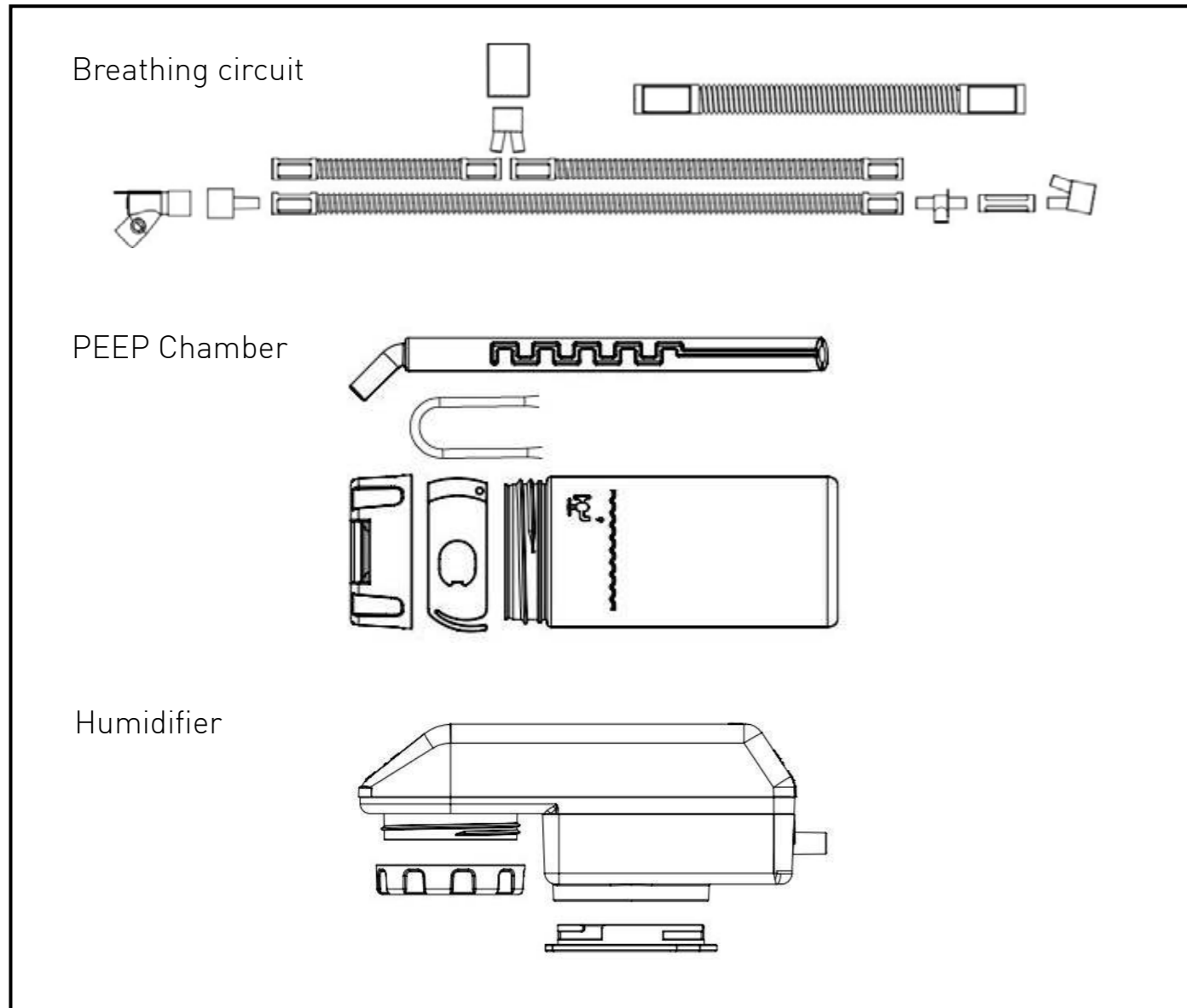

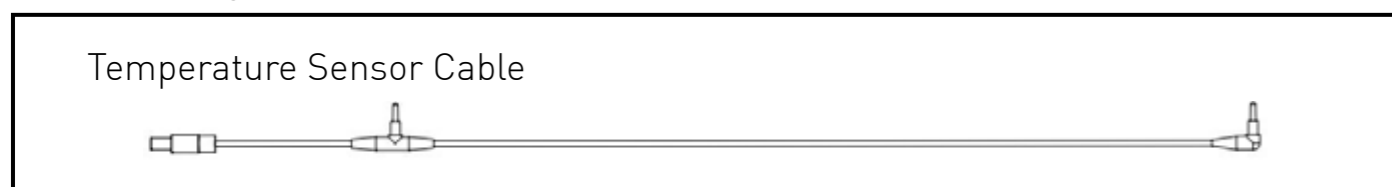

Process using step 4 only.



Reprocessing (CPAP)

2. Cleaning

 Do not include the temperature sensor cable in this step.

 If distilled water is not available, boiled water that has been cooled to tepid may be used.

The following equipment is needed for cleaning:



- Fill a sink or large bucket with distilled water and add mild detergent to form a detergent solution.
- One by one, submerge each part in the solution and wipe down with a cloth until clean. Use the small end of the brush to clean the small tube in the humidifier. Use the big end of the brush to clean inside the breathing tubes, PEEP column, and the gas input and output on the humidifier.
- After cleaning, rinse all of the parts in a large amount of distilled water to remove any residue from the cleaning process. Make sure that all surfaces are thoroughly rinsed, including the inside of the tubes and humidifier.
- After rinsing, leave all of the parts to dry completely before proceeding to the next step.

 If you do not allow the parts to dry, the autoclave and chemical disinfection steps may not be effective.

Reprocessing (CPAP)

3A. Autoclave

- ⚠ Re-sterilize by autoclave under 134°C and 15PSI
- ⚠ Do not include the temperature sensor cable in this step.

A. Autoclave the parts using the following parameters:

Method	Temperature	Exposure Time	Post-Treatment
Steam Autoclave (pre-vacuum)	134°C	4 minutes	Allow parts to cool and dry before proceeding.
Steam Autoclave (gravity displacement)	134°C	20 minutes	

- B. Carefully inspect all of the parts for signs of wear or damage. Discard any worn or damaged parts.
- C. Store all parts in a sterile container until use. To save time later, you can assemble the breathing circuit before storing it. To do this, follow the instructions in Step 3 of the *Setup (CPAP)* section.

3B. Chemical Disinfection

- ⚠ Remember to wear appropriate personal protective equipment (PPE) and work in a well-ventilated area.
- ⚠ Do not include the temperature sensor cable in this step.

i If distilled water is not available, boiled water that has been cooled to tepid may be used.

Reprocessing (CPAP)

The following equipment is needed for disinfection:



2.4% Glutaraldehyde Solution



Distilled Water



Sink or Bucket

- A. Add 2.4% glutaraldehyde solution to a sink or bucket
- B. Submerge all parts in the solution and rearrange them to remove any air bubbles from inside the parts. This will allow the solution to contact the entire inner surface of each part.
- C. Allow the parts to disinfect for 45 minutes at 25°C. To reduce exposure to glutaraldehyde fumes, which can be irritating, cover the container with a lid during this step.
- D. After 45 minutes, remove the parts from the solution and rinse them thoroughly in a container of distilled water. Make sure to flush the inside of the hollow parts with water. Repeat the rinsing procedure twice for a total of three rinses, using a fresh volume of water for each rinse. You may use a final rinse of 70% isopropyl alcohol solution to shorten the drying process.
- E. Allow the parts to dry completely.
- F. Once dry, carefully inspect all of the parts for signs of wear or damage. Discard any worn or damaged parts.
- G. Store all of the parts in a sterile container until use.

- i** Note that certain glutaraldehyde solutions are reusable for a limited period of time. Follow the guidelines of the glutaraldehyde manufacturer for storage and reuse of the glutaraldehyde solution.
- i** When disposing of the glutaraldehyde solution, follow manufacturer and local government recommendations.

Reprocessing (CPAP)

4. Temperature sensor cable cleaning and disinfection

The following equipment is needed for cleaning:



70%
Alcohol







Clean
Cloth

To clean and disinfect temperature cable sensor, use a clean cloth moistened with 70% Alcohol (preferably Ethanol) to gently wipe the temperature tips and the wire.

Reprocessing (CPAP)

5. Cleaning the outer surface of the Dolphin CPAP

To clean the display panel or outer surface of the Dolphin CPAP housing, use a clean cloth moistened with a mild detergent solution to gently wipe the target surfaces.

-  Do not allow liquids to enter the interior of the instrument.
-  Use the detergent solution sparingly. Excessive solution can flow into the device and cause damage to internal components.
-  Do not touch, press, or rub the display with abrasive cleaning compounds, instruments, brushes, rough-surface materials, or bring them into contact with anything that could scratch the display's surface.
-  Do not use alcohol, petroleum-based or acetone solutions, or other harsh solvents, to clean the device. These substances attack the device's materials and device failure can result.

Maintenance (CPAP)

The Dolphin CPAP includes a number of parts that must be replaced or serviced during the lifetime of the device. These parts include:

Component	Approx. Duration of Use	Maintenance Information
Humidifier	2 years or 150 uses	Replace parts when needed
PEEP chamber		
Breathing circuit		
Cleaning brush		
Air filter	6 months	Clean/replace according to step 1 in this section.
Oxygen sensor	18 months	Calibrate every 3 months according to step 2 in this section.

Maintenance (CPAP)

1. Air filter replacement

A. Turn off the device and disconnect the power cord.

B. Use a Philips head screwdriver to remove the screws on the bottom hatch of the device. Remove the bottom hatch completely and place it on the table



C. Gently take the filter from the bottom and replace with a clean one.



 The smoothed surface of the filter must face upwards. The filter must touch the muffler and fit the frame.

2. Oxygen sensor calibration

The oxygen sensor should be calibrated once every 3 months.

To calibrate the oxygen sensor:

A. Disconnect humidifier, temperature sensor, oxygen input and breathing circuit.

B. Turn on the device.

C. Begin calibration by pressing and holding the following buttons for 5 seconds: FiO₂ up arrow, FiO₂ down arrow, alarm silence button.

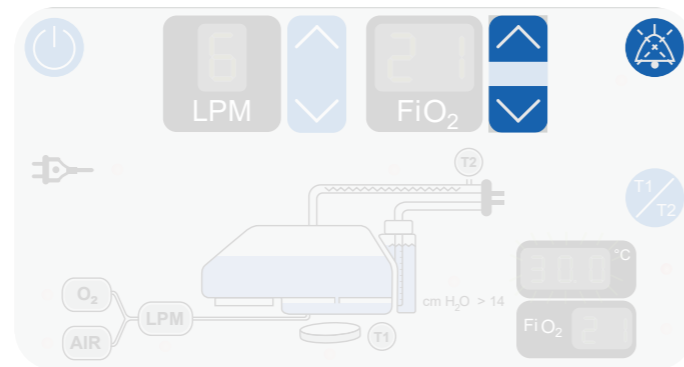



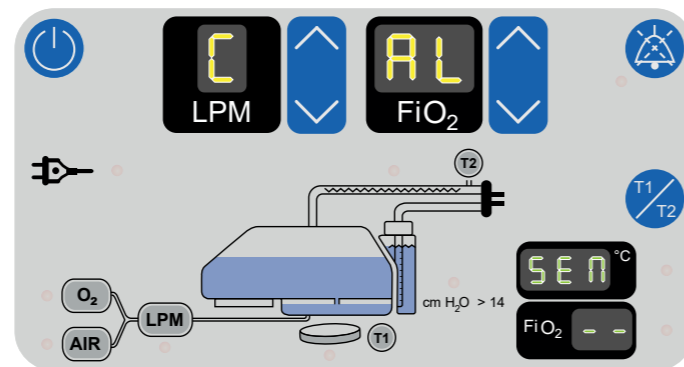





D. After holding the buttons for 5 seconds, the device will enter sensor calibration mode. While the sensor is calibrating, the CAL SEN message will illuminate as shown in the picture. The calibration may take up to two minutes.









E. Turn off the device.

Warnings (Pulse Oximeter)

-  The Dolphin CPAP is to be operated by qualified personnel only. This manual, accessory Directions for Use, all precautionary information, and specifications should be read before use.
-  Explosion hazard. Do not use the Dolphin CPAP in the presence of flammable anesthetics or other flammable substance in combination with air, oxygen-enriched environments, or nitrous oxide.
-  Electrical shock hazard. An operator may only perform maintenance procedures specifically described in this manual. If further maintenance is required, contact your MTTs representative to repair this equipment.
-  Do not modify this equipment without authorization of the manufacturer.
-  Using the device outside of the specified ambient temperature range (19°C to 37°C) or humidity range (30%RH to 90%RH) can compromise performance.
-  Do not operate the device if any of the components appear to be damaged or broken. Damaged or broken components should be discarded and replaced.
-  Do not position the device in a location that reduces its ventilation. Do not block any of the air vents on the sides or bottom of the device.
-  The presence of electro-surgical devices, shortwave or microwave equipment near this device could lead to electrical interference that negatively affects the function of the device.
-  As with all medical equipment, carefully route patient cabling to reduce the possibility of patient entanglement or strangulation.

Warnings (Pulse Oximeter)

-  Do not use the device or pulse oximetry sensors during magnetic resonance imaging (MRI) scanning. Induced current could potentially cause burns. The device may affect the MRI image, and the MRI unit may affect the accuracy of the oximetry measurements.
-  A pulse oximeter should NOT be used as an apnea monitor.
-  Pulse rate measurement is based on the optical detection of a peripheral flow pulse and therefore may not detect certain arrhythmias. The pulse oximeter should not be used as a replacement or substitute for ECG based arrhythmia analysis.
-  A pulse oximeter should be considered an early warning device. As a trend towards patient deoxygenation is indicated, blood samples should be analyzed by a laboratory co-oximeter to completely understand the patient's condition.
-  Interfering Substances: Carboxyhemoglobin may erroneously increase readings. The level of increase is approximately equal to the amount of carboxyhemoglobin present. Dyes, or any substance containing dyes, that change usual arterial pigmentation may cause erroneous readings.
-  A functional tester cannot be utilized to assess the accuracy of the Pulse Oximeter or any sensors.

Overview (Pulse Oximeter)

General Description

Pulse oximetry is a continuous and non-invasive method of measuring the level of arterial oxygen saturation in blood. The measurement is taken by placing a sensor on the patient, usually on the hand or foot for neonates. The sensor connects to the pulse oximetry instrument directly or with a patient cable. The sensor collects signal data from the patient and sends it to the instrument. The instrument displays the calculated data in two ways:

1. As a percent value for arterial oxygen saturation (SpO₂) and
2. As a pulse rate (bpm).

Principle of Operation

Pulse oximetry is governed by the following principles:

1. Oxyhemoglobin (oxygenated blood) and deoxyhemoglobin (non-oxygenated blood) differ in their absorption of red and infrared light (spectrophotometry).
2. The amount of arterial blood in tissue changes with your pulse (photoplethysmography). Therefore, the amount of light absorbed by varying quantities of arterial blood changes as well.

The Dolphin CPAP incorporates the selection of Masimo SET and MTTs technology which uses a two-wavelength pulsatile system to distinguish between oxygenated and deoxygenated blood. Signal data is obtained by passing red (rd) (660 nm Masimo, 660 ± 3 nm MTTs) and infrared (ir) (905 nm Masimo, 905 ± 10 nm MTTs) light through a capillary bed (for example a fingertip, a hand or a foot) and measuring changes in light absorption during the pulsatile cycle. This information may be useful to clinicians. The Dolphin CPAP utilizes a sensor with red and infrared light-emitting diodes (LEDs) that pass light through the site to a photodiode (photodetector). The radiant power of the light is rated at 0.79mW (max.) for Masimo and <16 mW from MTTs. The photodetector receives the light, converts it into an electronic signal and sends it to the Dolphin CPAP for calculation.

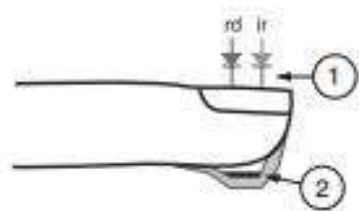

1	Light Emitting Diodes (LEDs)
2	Recessed Photo Detector

Overview (Pulse Oximeter)

Once the Dolphin CPAP receives the signal from the sensor, it utilizes pulse oximeter signal extraction technology for calculation of the patient's functional oxygen saturation and pulse rate. The maximum of the skin surface temperature is measured at an ambient temperature of less than 106°F (41°C) for Masimo and 122°F (50°C) for MTTs. This is verified by sensor skin temperature test procedures.

Functional vs. Fractional Saturation

The Dolphin CPAP is calibrated to measure and display functional saturation which is the amount of oxygenated hemoglobin expressed as a percentage of the hemoglobin that can transport oxygen. The Dolphin CPAP does not measure fractional saturation which is oxygenated hemoglobin expressed as a percentage of all measured hemoglobin. This includes measured dysfunctional hemoglobin such as carboxyhemoglobin or methemoglobin. To convert fractional saturation to functional saturation, the fractional saturation measurements must be converted according to:

$$\text{Functional saturation} = \frac{\text{Fractional saturation}}{100 - (\% \text{ carboxyhemoglobin} + \% \text{ methemoglobin})} \times 100$$

Measured vs. Calculated Saturation

Oxygen saturation measurements obtained from a pulse oximeter are commonly compared to saturations calculated from the partial pressure of oxygen (PO₂) obtained from an arterial blood gas sample. When comparing the two measurements and interpreting values, caution should be used, as the calculated value obtained from the blood gas sample may differ from the SpO₂ measurement of the pulse oximeter. Different results are usually obtained from the blood gas sample if the calculated saturation is not appropriately corrected for the effects of variables that shift the relationship between PO₂ and saturation, such as: pH, temperature, the partial pressure of carbon dioxide (PCO₂), 2,3-DPG, and fetal hemoglobin. Also, as blood gas samples are usually taken over a period of 20 seconds (the time it takes to draw blood) a meaningful comparison can only be achieved if the core oxygen saturation of the patient is stable and not changing over the period of time that the blood gas sample is taken.

Overview (Pulse Oximeter)

Masimo SET Signal Extraction Technology*

Masimo Signal Extraction Technology's signal processing differs from conventional pulse oximeters. Conventional pulse oximeters assume that arterial blood is the only blood moving (pulsating) in the measurement site. During patient motion, however, the non-arterial blood also moves, causing conventional pulse oximeters to read low values, because they cannot distinguish between the arterial and venous blood movement (sometimes referred to as noise). Masimo SET pulse oximetry utilizes parallel engines and adaptive digital filtering. Adaptive filters are powerful because they are able to adapt to the varying physiologic signals and/or noise and separate them by looking at the whole signal and breaking it down to its fundamental components. The Masimo SET signal processing algorithm, Discrete Saturation Transform[®] (DST)[®], reliably identifies the noise, isolates it and, using adaptive filters, cancels it. It then reports the true arterial oxygen saturation for display on the monitor.

MASIMO SET PARALLEL ENGINES

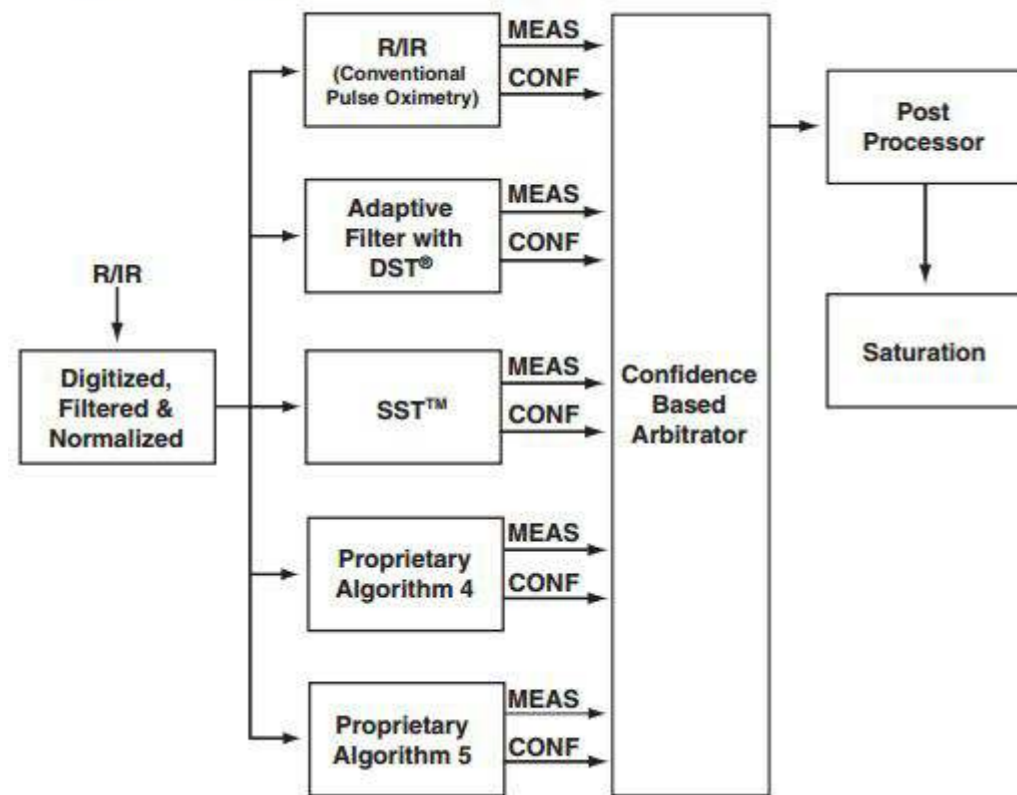

*this information is relevant only to the devices using Masimo SET technology

Overview (Pulse Oximeter)

MASIMO SET DST

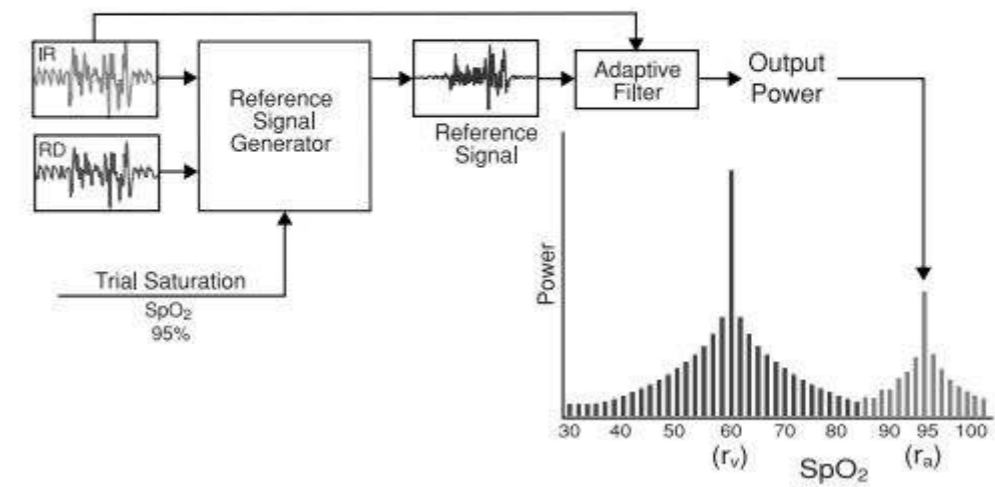



Setup (Pulse Oximeter)

1. Plug in the Dolphin CPAP (if it is not already plugged in).

- A. Attach the power cord to the AC power inlet on the back of the Dolphin CPAP.
- B. Locate an AC power source with adequate power rating for the Dolphin CPAP. The power requirements for the device are listed on the back panel and in the *Specifications* section.
- C. Connect the power cord to the appropriate AC power source.

 Only connect the Dolphin CPAP to a three-wire, grounded, hospital-grade receptacle. The three-conductor plug must be inserted into a properly wired three-wire receptacle; if a three-wire receptacle is not available, a qualified electrician must install one in accordance with the governing electrical code.

 Do not under any circumstances remove the grounding conductor from the power plug.

 Do not use extension cords or adapters of any type. The power cord and plug must be intact and undamaged.

 To ensure patient electrical isolation, connect only to other equipment with electronically isolated circuits.

 Do not connect the Dolphin CPAP to an electrical outlet controlled by a wall switch or dimmer.

Setup (Pulse Oximeter)

2. Connect the patient cable and sensor.

- A. Connect the patient cable to the Masimo Patient Cable Connector on the front of the device. Make sure it is a firm connection and the cable is not twisted, sliced or frayed.
- B. Select a compatible sensor in accordance with the *Sensors & Patient Cables (Pulse Oximeter)* section of this user manual.
- C. If using a reusable sensor, make sure it opens and closes smoothly. Remove any substances that may interfere with the transmission of light between the sensor's light source and photodetector.
- D. Refer to the Directions for Use of the sensor before attaching the sensor to the patient. If using a single patient adhesive or disposable sensor, check that the emitter (red light) and photodetector are properly aligned.
- E. With a single patient adhesive or disposable sensor, connect the sensor to the patient cable with the logos lining up; make sure it is a firm connection.

Operation (Pulse Oximeter)

1. Power on the Pulse Oximeter display.

- A.** Make sure the rocker switch on the back panel is in the on-position. If the CPAP display is currently lit, the rocker switch is already in the on-position.



- B.** Press and hold the power button on the Pulse Oximeter display for two seconds to turn it on.

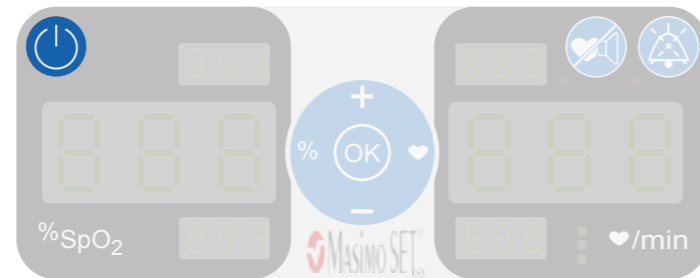

- C.** After turning on the Pulse Oximeter display, all of the lights will turn on and an alarm tone will sound briefly.

i If an error is detected by the Dolphin CPAP at this time, an error message will be indicated using ERR and a number on the display. If this happens, note the error number and contact your MTTs representative.

- D.** The saturation display and pulse rate display will continue flashing "---" until patient values have been acquired (approximately 10 seconds).



Operation (Pulse Oximeter)

2. Set the SpO₂ alarm limits.

To adjust patient SpO₂ alarm limits:

- A.** Press the percent button to begin adjusting the SpO₂ alarm limits. Pressing this button will cause the SpO₂ upper alarm limit to start flashing.

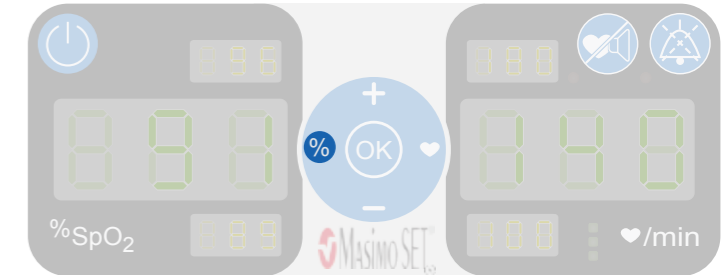

- B.** While the SpO₂ upper alarm limit is flashing, use the up and down arrows to adjust the alarm limit. When the target number has been reached, press the OK button. Pressing this button will cause the SpO₂ lower alarm limit to start flashing.

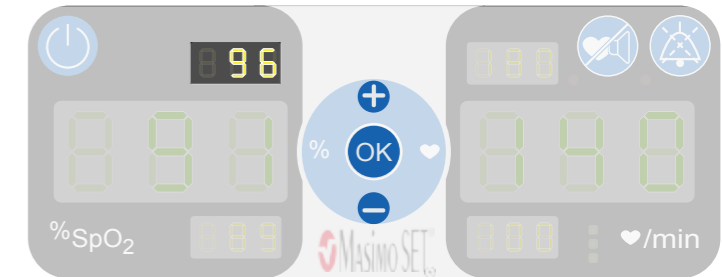

- C.** While the SpO₂ lower alarm limit is flashing, use the up and down arrows to adjust the alarm limit. When the target number has been reached, press the OK button.



Operation (Pulse Oximeter)

3. Set the pulse rate alarm limits.

To adjust patient pulse rate alarm limits:

- A.** Press the heart button to begin adjusting the pulse rate alarm limits. Pressing this button will cause the upper alarm limit to start flashing.

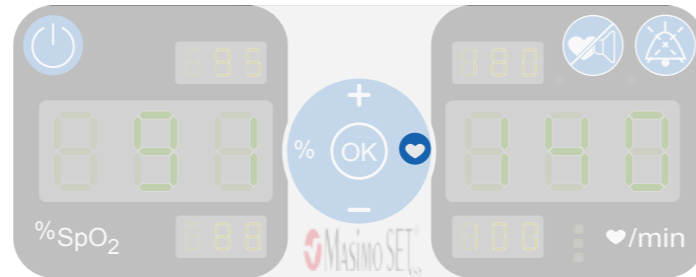

- B.** While the upper alarm limit is flashing, use the up and down arrows to adjust the alarm limit. When the target number has been reached, press the OK button. Pressing this button will cause the lower alarm limit to start flashing.

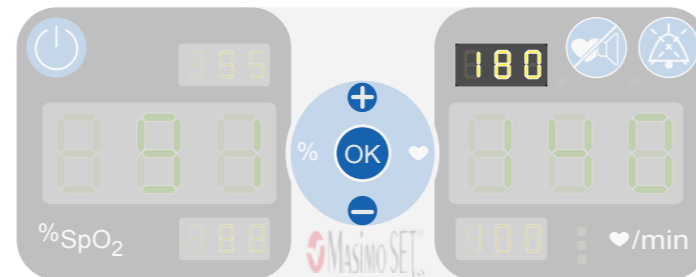

- C.** While the lower alarm limit is flashing, use the up and down arrows to adjust the alarm limit. When the target number has been reached, press the OK button.

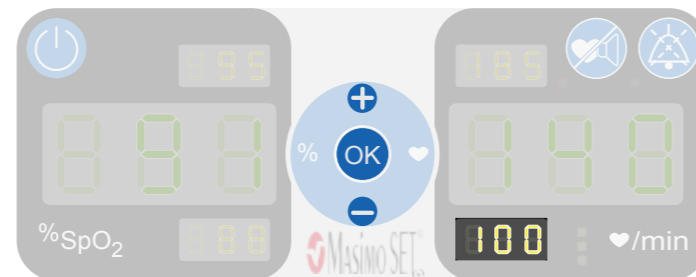

Operation (Pulse Oximeter)

4. Verify the SpO₂ and pulse rate alarms are functional.

- A.** Set the SpO₂ upper alarm limit below the patient's SpO₂ reading. Confirm that an alarm tone sounds, the SpO₂ display flashes, and three red lights flash.
- B.** Set the SpO₂ lower alarm limit above the patient's SpO₂ reading. Confirm that an alarm tone sounds, the SpO₂ display flashes, and three red lights flash.
- C.** Repeat steps A and B, varying the pulse rate upper and lower alarm limits instead of the SpO₂ alarm limits.

5. Verify the sensor alarms are functional.

- A.** Remove the sensor from the sensor site. Confirm the alarm tone sounds, the message "cH SEn" is displayed, and three red lights flash.
- B.** Disconnect the sensor from the patient cable or device. Confirm the alarm tone continues to sound, the message "no SEn" is displayed, and three red lights flash.

6. Verify the alarm silence mode is functional.

- A.** Create an alarm condition by adjusting one of the alarm limits.
- B.** Press the alarm silence button. Confirm that no alarm tones start for the next 110 seconds, and that the yellow light next to the alarm silence button is lit.



Operation (Pulse Oximeter)

7. To begin patient monitoring:

- A. Adjust the alarm limits.
- B. Use the pulse sound button to toggle between an enabled or disabled pulse sound.

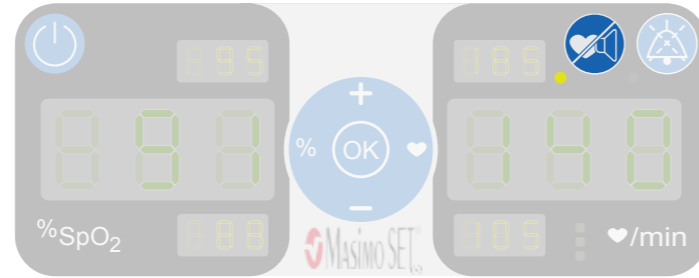

- C. Verify the sensor is applied correctly and that the measured data is appropriate. See subsection *Successful Monitoring* that begins on the next page.

8. After monitoring is complete:

- A. Remove the sensor from the patient and store or dispose of the sensor according to local laws. See the Directions for Use of the sensor.
- B. Press and hold the power button for 2 seconds to turn off the pulse oximeter display.



i If the Dolphin CPAP loses mains power, the SpO₂ and pulse rate alarm values will be saved until the pulse oximeter display is next powered on. If the Dolphin CPAP is turned off using the power button, no alarm limit values will be saved.

Operation (Pulse Oximeter)

Successful Monitoring

The following general points will aid in ensuring monitoring success.

- Place the sensor on a site that has sufficient perfusion and provides proper alignment of the LEDs and detector.
- Place the sensor on a site that has unrestricted blood flow.
- Do not secure a sensor with tape.
- Do not select a site near potential electrical interference (for example, an electro-surgical device).
- Read the sensor Directions for Use for proper sensor application.

MASIMO PULSE OXIMETRY SENSORS*

Before use, carefully read the Masimo sensor Directions for Use. Use only Masimo sensors for pulse oximetry measurements. Tissue damage can be caused by incorrect application or use of a sensor, for example by wrapping the sensor too tightly. Inspect the sensor site as directed in the sensor Directions for Use to ensure skin integrity and correct positioning and adhesion of the sensor.

- !** Do not use damaged sensors. Do not use a sensor with exposed optical or electrical components. Do not immerse the sensor in water, solvents, or cleaning solutions (the sensors and connectors are not waterproof). Do not sterilize by irradiation, steam, or ethylene oxide. See the cleaning instructions in the Directions for Use for reusable Masimo sensors.
- !** Do not use damaged patient cables. Do not immerse the patient cables in water, solvents, or cleaning solutions (the patient cable connectors are not waterproof). Do not sterilize by irradiation, steam, or ethylene oxide.
- !** Do not attempt to reprocess, recondition or recycle Masimo sensors or patient cables as these processes may damage the electrical components, potentially leading to patient harm.

* the devices using Masimo SET technology only

MEASUREMENTS

If the accuracy of any measurement does not seem reasonable, first check the patient's vital signs by alternate means and then check the Pulse Oximeter for proper functioning.

Inaccurate measurements may be caused by:

- Incorrect sensor application or use.
- Significant levels of dysfunctional hemoglobins (e.g., carboxyhemoglobin or methemoglobin).
- Intravascular dyes such as indocyanine green or methylene blue.
- Interfering Substances: Dyes, nail polish or any substance containing dyes, that change usual blood pigmentation may cause erroneous readings.
- Pulse rate measurement is based on the optical detection of a peripheral flow pulse and therefore may not detect certain arrhythmias. The pulse oximeter should not be used as a replacement or substitute for ECG based arrhythmia analysis.
- Exposure to excessive illumination, such as surgical lamps (especially ones with a xenon light source), bilirubin lamps, fluorescent lights, infrared heating lamps, or direct sunlight (exposure to excessive illumination can be corrected by covering the sensor with a dark or opaque material).
- Excessive patient movement.
- SpO₂ is empirically calibrated to functional arterial oxygen saturation in healthy adult volunteers with normal levels of carboxyhemoglobin (COHb) and methemoglobin (MetHb). A pulse oximeter cannot measure elevated levels of COHb or MetHb. Increases in either COHb or MetHb will affect the accuracy of the SpO₂ measurement.
 - For increased COHb: COHb levels above normal tend to increase the level of SpO₂. The level of increase is approximately equal to the amount of COHb that is present.
 - High levels of COHb may occur with a seemingly normal SpO₂. When elevated levels of COHb are suspected, laboratory analysis (CO-Oximetry) of a blood sample should be performed.
 - For increased MetHb: the SpO₂ may be decreased by levels of MetHb of up to approximately 10% to 15%. At higher levels of MetHb, the SpO₂ may tend to read in the low to mid 80s. When elevated levels of MetHb are suspected, laboratory analysis (CO-Oximetry) of a blood sample should be performed.

- Venous congestion may cause under reading of actual arterial oxygen saturation. Therefore, assure proper venous outflow from monitored site. Sensor should not be below heart level (e.g. sensor on hand of a patient in a bed with arm dangling to the floor).
- Venous pulsations may cause erroneous low readings (e.g. tricuspid valve regurgitation).
- Patient suffers from abnormal pulse rhythm.
- The pulsations from intra-aortic balloon support can be additive to the pulse rate on the oximeter pulse rate display. Verify patient's pulse rate against the ECG heart rate.
- Use only MTTs approved accessories.
- Motion artifact may lead to inaccurate measurements.
- Elevated levels of Total Bilirubin may lead to inaccurate SpO₂ measurements.
- With very low perfusion at the monitored site, the readings may read lower than core arterial oxygen saturation.
- Do not expose the Pulse Oximeter to excessive moisture such as direct exposure to rain. Excessive moisture can cause the Pulse Oximeter to perform inaccurately or fail.
- Do not immerse the sensor or patient cable in water, solvents, or cleaning solutions (the sensors and connectors are not waterproof).
- Placement of a sensor on an extremity with a blood pressure cuff, arterial catheter, or intravascular line.

The Pulse Oximeter can be used during defibrillation, but the readings may be inaccurate for a short time.

Loss of pulse signal can occur in any of the following situations:

- The sensor is too tight.
- There is excessive illumination from light sources such as a surgical lamp, a bilirubin lamp, or sunlight.
- A blood pressure cuff is inflated on the same extremity as the one with a SpO₂ sensor attached.
- The patient has hypotension, severe vasoconstriction, severe anemia, or hypothermia.
- There is arterial occlusion proximal to the sensor.
- The patient is in cardiac arrest or is in shock.

Alarm System (Pulse Oximeter)

i CPAP therapy has a separate alarm system explained in the *Alarm System (CPAP)* section.

The pulse oximeter alarm system will generate visual and audible alarm signals to notify you of alarm conditions that the system detects.

1. Alarm Identification

Two levels of alarm priority are implemented: high and low priority. The following table outlines the alarm priority specifications:

Alarm Priority	Parameter	Alarm Type
High	Low saturation (SpO ₂ , range 1-99%)	Audible and visual
	High saturation (SpO ₂ , range 2-100%)	
	Low pulse rate (pulse rate range 30-199 bpm)	
	High pulse rate (pulse rate range 35-235 bpm)	
	Sensor off and no sensor	
	System failure	
Low	Low perfusion index	

2. Alarm Indication

An alarm condition is indicated by:

- Audible alarm tone
- Visual alarm indicator (3 flashing red lights)
- Out-of-limit parameter will flash

Sensor off and no sensor alarms will only generate an alarm condition after a pulse has been found.

Alarm System (Pulse Oximeter)

3. Alarm Limits

! Check alarm limits each time the Pulse Oximeter is used to ensure that they are appropriate for the patient being monitored.

An audible alarm and a flashing alarm status indicator will occur when an alarm limit is exceeded. It is best that the operator be within a maximum of 1 meter from the unit. Directions for alarm silence are indicated in the previous section. When a sensor is not connected to a patient the text "SEn oFF" will illuminate and 3 red lights will flash. When a sensor is not connected to its cable, the text "no SEn" will illuminate and 3 red lights will flash. An audible alarm will accompany the visual indicator unless the Pulse Oximeter has been set to alarm silence mode.

Step-by-step instructions for configuring the alarm limits are given in steps 2 and 3 of the section *Operation (Pulse Oximeter)*. The default value and range of the alarm limits are as follows:

Setting	Default Value	Range
SpO ₂ Low Limit	89 %SpO ₂	The SpO ₂ low alarm limit can be set anywhere between 1% and 99%, with a 1% step size.
SpO ₂ High Limit	96 %SpO ₂	The SpO ₂ high alarm limit can be set anywhere between 2% and 100% with a 1% step size.
Pulse Rate Low Limit (BPM)	100 bpm	The pulse rate low alarm limit can be set anywhere between 30 BPM and 199 BPM, with a 5 BPM step size.
Pulse Rate High Limit (BPM)	180 bpm	The pulse rate high alarm limit can be set anywhere between 35 BPM and 235 BPM, with a 5 BPM step size.

i The low alarm limit must always be set below the high alarm limit. Attempting to set the high alarm limit below the low alarm limit will not work. In order to set the high alarm limit below the current low alarm limit, you must first change the low alarm limit setting.

i If there is a loss of mains power and the CPAP display is on, the Pulse Oximeter alarm values will be saved. If the Pulse Oximeter display is turned off using the power button or if there is a loss of mains power and the CPAP display is off, the Pulse Oximeter alarm values will return to default values.

Alarm System (Pulse Oximeter)



4. Alarm Silence

Audible alarms may be suspended, while visual alarms may not. The alarm silence button is used to temporarily silence audible alarms for 110 seconds. When this button is pressed, a yellow light is illuminated next to the button and audible alarms are silenced. When the button is pressed and the yellow light is already on, the yellow light turns off and alarm sounds are restored.







Symbol	Description
	Press this button to temporarily silence Pulse Oximeter alarm sounds for 110 seconds. Press it again to restore alarm sounds.

5. Alarm and information signals

The pulse oximeter alarm system will indicate the following alarm and information signals:

Symbol	Description	Solution
	System failure	Turn the machine off and then on again. If the error message is still present, note the error number and contact your MTTs representative.
	Low perfusion index	(1) Rule out occlusion of blood flow. (2) Attempt to warm patient. (3) Move sensor to better perfused site. NOTE: Masimo recommends using an adhesive sensor whenever low perfusion is expected or evident.
	Sensor not connected to patient	Connect the sensor to the patient.

Alarm System (Pulse Oximeter)

Symbol	Description	Solution
	Sensor not connected to device or cable	Connect the sensor to the device or cable.
	Interference detected	Ensure that the sensor is properly applied, and cover the sensor site with opaque material, if required.
	Sensor defective or unrecognized	Replace the sensor.
	Cable not connected to device	Connect the cable to the device.
	Adhesive sensor not connected to device or cable	Connect the adhesive sensor to the device or cable.
<i>SpO₂ value flashing</i>	May indicate poor data quality (Low signal IQ or Low Perfusion Index)	(1) Rule out occlusion of blood flow. (2) Verify placement of sensor.
<i>Pulse value flashing</i>	May indicate poor data quality (pulse rate still calculating)	Wait for pulse to finish calculating. (This may occur when a sensor is first applied to a patient).
	Pulse search	Wait for found pulse. (This search should occur whenever a sensor is first applied to a patient).

Sensors & Patient Cables (Pulse Oximeter)

This section covers the use and cleaning of Masimo SET sensors and Masimo SET patient cables*.

Masimo SpO₂ sensors

Before use of any sensor or cable, carefully read the sensor or cable Directions for Use. Use only Masimo oximetry sensors and cables for SpO₂ measurements. Other oxygen transducers or sensors may cause improper pulse oximeter performance. Tissue damage can be caused by incorrect application or use of a Masimo sensor, for example by wrapping the sensor too tightly. Inspect the sensor site as directed in the sensor Directions for Use to ensure skin integrity and correct positioning and adhesion of the sensor.

 Do not use damaged sensors. Do not use a sensor with exposed optical or electrical components. Do not immerse the sensor in water, solvents, or cleaning solutions (the sensors and connectors are not waterproof). Do not sterilize by irradiation, steam, or ethylene oxide. See the cleaning instructions in the Directions for Use for reusable Masimo sensors.

 Do not use damaged patient cables. Do not immerse the patient cables in water, solvents, or cleaning solutions (the patient cable connectors are not waterproof). Do not sterilize by irradiation, steam, or ethylene oxide.

 All sensors and cables are designed for use with specific monitors. Verify the compatibility of the monitor, cable and sensor before use, otherwise patient injury can result.

 Do not use additional tape to wrap sensor.

* the devices using Masimo SET technology only

Sensors & Patient Cables (Pulse Oximeter)

Selecting a Masimo SET sensor

When selecting a sensor, consider the patient's weight, the adequacy of perfusion, the available sensor sites, and the duration of monitoring. For more information refer to the following table or contact your MTTs representative. Use only Masimo SET sensors and sensor cables. Select an appropriate sensor, apply it as directed, and observe all warnings and cautions presented in the Directions for Use accompanying the sensor. High ambient light sources such as surgical lights (especially those with a xenon light source), bilirubin lamps, fluorescent lights, infrared heating lamps, and direct sunlight can interfere with the performance of an SpO₂ sensor. To prevent interference from ambient light, ensure that the sensor is properly applied, and cover the sensor site with opaque material, if required. Failure to take this precaution in high ambient light conditions may result in inaccurate measurements.

Sensor Application Instructions

Unless indicated otherwise in the Directions for Use, reposition reusable sensors at least every 4 hours and for adhesive sensors inspect the site at least every 8 hours or sooner. If indicated by circulatory condition or skin integrity, reapply to a different monitoring site.

RECOMMENDED SENSORS

Sensor	Description	Weight Range	Saturation Accuracy		Pulse Rate Accuracy		Low Perfusion Accuracy	
			No Motion	Motion	No Motion	Motion	Saturation	Pulse Rate
Reusable sensor								
M-LNCS™ YI	Reusable Multi-site Sensor	> 1kg	± 3%	± 3%	± 3 bpm	± 5 bpm	± 3%	± 3 bpm
Adhesive sensor								
M-LNCS™ NeoPt	Sensitive Skin Neonate Adhesive Sensor	< 1kg	± 3%	± 3%	± 3 bpm	± 5 bpm	± 3%	± 3 bpm

 M-LNCS™ sensors must be used in conjunction with M-LNC™ cables.

Sensors & Patient Cables (Pulse Oximeter)

i These sensors are recommended because they are compatible with the Dolphin CPAP and are often appropriate for the Dolphin CPAP's target patient population. This is NOT a complete list of sensors compatible with the Dolphin CPAP. Contact your MTTs representative for a full list of compatible sensors.

Cleaning and reuse of Masimo sensors

Reusable sensors can be cleaned per the following procedure:

- Remove the sensor from the patient.
- Disconnect the sensor from the Dolphin CPAP.
- Wipe the entire sensor clean with a 70% isopropyl alcohol pad.
- Allow the sensor to air dry before returning it to operation.

Reattachment of single use adhesive sensors

- Single use sensors may be reapplied to the same patient if the emitter and detector windows are clear and the adhesive still adheres to the skin.

i If the sensor fails to track the pulse consistently, the sensors may be incorrectly positioned. Reposition the sensor or choose a different monitoring site.

- !** To avoid cross contamination only use Masimo single use sensors on the same patient.
- !** Do not reprocess any single use sensors.
- !** Do not soak or immerse the sensor in any liquid solution. Do not sterilize any Masimo sensor by irradiation, steam, or ethylene oxide.

Sensors & Patient Cables (Pulse Oximeter)

Masimo SET patient cables

Reusable patient cables of various lengths are available. Only use appropriate Masimo oximetry cables for SpO₂ measurements. Other patient cables may cause improper Pulse Oximeter performance.

RECOMMENDED PATIENT CABLES

Cable	Description
M-LNC™	M-LNCS™ Series Patient Cable

i This cable is recommended because it is compatible with the recommended sensors. This is NOT a complete list of cables compatible with the Dolphin CPAP. Contact your MTTs representative for a full list of compatible cables.

Cleaning and reuse of Masimo SET patient cables

Patient cables can be cleaned per the following procedure:

- Remove the cable from the sensor.
- Disconnect the sensor from the Dolphin CPAP.
- Wipe clean with a 70% isopropyl alcohol pad.
- Allow the cable to dry before returning it to operation.

- !** Carefully route patient cables to reduce the possibility of patient entanglement or strangulation.
- !** Do not soak or immerse patient cables in any liquid solution. Do not sterilize patient cables by irradiation, steam, or ethylene oxide. See the cleaning instructions in the Directions for Use for reusable Masimo patient cables.
- !** Do not reprocess any Masimo SET patient cables.





Maintenance (Pulse Oximeter)

Under normal operation, no internal adjustment or recalibration is required to operate the pulse oximeter of the Dolphin CPAP. If you think maintenance is required, contact your MTTs representative.

 Before cleaning the pulse oximeter display, always turn it off and make sure the AC power cord is disconnected.

Cleaning

To clean the display panel or outer surface of the Dolphin CPAP housing, use a clean cloth moistened with a mild detergent solution to gently wipe the target surfaces.

-  Do not allow liquids to enter the interior of the instrument.
-  Use the detergent solution sparingly. Excessive solution can flow into the device and cause damage to internal components.
-  Do not touch, press, or rub the display with abrasive cleaning compounds, instruments, brushes, rough-surface materials, or bring them into contact with anything that could scratch the display's surface.
-  Do not use alcohol, petroleum-based or acetone solutions, or other harsh solvents, to clean the device. These substances attack the device's materials and device failure can result.

 Refer to the previous section *Sensors & Patient Cables (Pulse Oximeter)* for cleaning instructions for sensors and patient cables.

Maintenance (Pulse Oximeter)

Service and repair

Do not use the Dolphin CPAP if the pulse oximetry monitoring features are malfunctioning. Have the unit repaired. In order to have the unit repaired, contact your MTTs representative.

Performance Verification

To test the performance of the pulse oximeter following repairs or during routine maintenance, follow the procedure outlined in this section. If the pulse oximeter fails any of the described tests, discontinue its use and correct the problem before reconnecting the device to the patient.

Before performing the following tests, verify the device is connected to AC power and disconnect any patient cables or pulse oximetry probes from the device.

Power-On Self-Test:

1. Turn the monitor on by pressing and holding the power button for 2 seconds. All available LEDs will illuminate and a brief alarm tone will sound.
2. The pulse oximeter will begin normal operation.

Key Press Button Test:

1. Press the alarm silence button and the pulse sound silence button each once. Verify that the light adjacent to each button toggles on or off at the press of the button.

Alarm Limit Test:

1. Initiate a change in saturation alarm limits by pressing the "percent sign" button. Change the high saturation alarm parameter to a value two points below the currently selected value. Press OK. Change the low saturation alarm parameter to a value two points below the currently selected value. Press OK.
2. Initiate a change in pulse rate alarm limits by pressing the "heart" button. Change the high pulse rate alarm parameter to a value five points above the currently selected value. Press OK. Change the low pulse rate alarm parameter to a value five points above the currently selected value. Press OK.

Specifications

Performance Specifications (CPAP)

Control Settings

Set flow rate	Default	6 L/min
	Range	4 - 9 L/min
Set FiO ₂	Default	21 %FiO ₂
	Range	21 - 99 %FiO ₂
Humidifier temperature probe (T1)	Default	34.0 °C
	Range	31.0 - 37.0 °C
Airway temperature probe (T2)	Default	37.0 °C
	Range	35.0 - 40.0 °C

Displays

Measured temperature display	Accuracy	±1 °C
	Range	18.0 - 50.0 °C
		"Lo" when value is below 18°C
		"hi" when value is above 50°C
Measured FiO ₂ display	Accuracy	±5 %FiO ₂
	Range	21 - 99 %FiO ₂

Humidifier

Warm-up time	≤10 minutes
Humidity performance	≥33 mg/L
Volume available for vaporization	Humidity chamber 20 mL
	Reservoir 1600 mL (maximum)
Maximum operating pressure	7 kPa
Heater plate overtemperature cutout	90 ± 5 °C

Specifications

Performance Specifications (CPAP)

Delivered pressure

The PEEP column can be set at integer values in the range of 1 - 10 cmH₂O.

The pressure delivered to the patient interface connection site is dependant on the PEEP column setting and the flow rate. The relationship between pressure delivered at the patient interface connection site, PEEP column setting, and flow rate is shown in the chart below.



These values may not be accurate if you do not use the recommended breathing circuit components, or if the PEEP bottle does not contain water even with the fill line.



The pressure delivered to the patient is lower than the pressure delivered to the patient interface connection site. This is because there is a pressure loss across the patient interface. Different patient interfaces have different amounts of pressure loss.

Pressure Delivered at the Patient Interface Connection Site [cmH₂O]

		Flow Rate Setting [L/min]					
		4	5	6	7	8	9
PEEP column setting [cmH ₂ O]	1	1.8	1.9	2.0	2.2	2.4	2.6
	2	2.8	2.9	3.0	3.2	3.4	3.6
	3	3.9	4.0	4.1	4.3	4.5	4.7
	4	4.9	5.0	5.1	5.3	5.5	5.7
	5	6.0	6.1	6.2	6.4	6.6	6.8
	6	6.9	7.0	7.1	7.3	7.5	7.7
	7	8.0	8.1	8.2	8.3	8.5	8.7
	8	8.9	9.0	9.1	9.2	9.4	9.6
	9	9.8	9.9	10.0	10.1	10.3	10.5
	10	10.8	10.9	11.0	11.2	11.3	11.4

Specifications

Performance Specifications (Pulse Oximeter)

Measurement Range

Arterial Oxygen Saturation [%SpO ₂] ¹		1% to 100%
Pulse Rate	MTTS	25 bpm to 300 bpm
	Masimo	25 bpm to 240 bpm
Perfusion Index	MTTS	1 to 10
	Masimo	0.02% to 20%
Response Time	MTTS ²	setup 3s, 5s or 7s
	Masimo	≤1 second delay

Accuracy – Arterial Oxygen Saturation

Saturation		70% to 100%
No Motion ³	Infants, Pediatrics	± 2%
	Neonates	± 3%
Motion ⁴	Infants, Pediatrics, Neonates	± 3%
Low Perfusion ⁵	Infants, Pediatrics, Neonates	± 2%

Accuracy – Pulse Rate

Pulse Rate	MTTS	25 – 300 (bpm) ± 2 bpm
	Masimo ⁶	25 – 240 (bpm)
No Motion	Infants, Pediatrics, Neonates	± 3 bpm
Motion	Infants, Pediatrics, Neonates	± 5 bpm
Low Perfusion	Infants, Pediatrics, Neonates	± 3 bpm

1. Masimo SpO₂ was determined by testing on healthy adult volunteers in the range 60%-100% SpO₂ against a laboratory CO-Oximeter. SpO₂ accuracy was determined on 16 neonatal NICU patients ranging in age from 7 to 135 days old and weighting between 0.5 and 4.25 kgs. Seventy-nine (79) data samples were collected over a range of 70 – 100% SaO₂ with a resultant accuracy of 2.9% SpO₂. Contact your MTTs representative for testing specifications.

MTTS SpO₂ was determined by testing on healthy adult volunteers in the range 64.2%-99.3% SpO₂, and the volunteers inhaled a certain concentration of oxygen-nitrogen gas mixture. SpO₂ accuracy was determined on 6 volunteers were tested, and 182 groups of valid contrast data were collected. The SpO₂ accuracy of MTTs module shall be a root-mean-square difference of less than 3.0 % SpO₂ over the range of 70 % to 100 % SaO₂, and Arms = 1.94. Contact your MTTs representative for testing specifications.

2. Sensitivity refers to the respond speed of updated measurement results with the changeable input signal. The host can set the sensitivity of the module, and the sensitivity includes 3 levels: high, medium and low, separately, the update cycle for the 3s, 5s, 7s.

3. Masimo SET technology with LNOP Adt sensors has been validated for motion accuracy in human blood studies on healthy adult male and female volunteers with light to dark skin pigmentation in induced hypoxia studies while performing rubbing and tapping motions, at 2 to 4 Hz at an amplitude of 1 to 2 cm and a non-repetitive motion between 1 to 4Hz at an amplitude of 2 to 3 cm in induced hypoxia studies in the range of 70-100% SpO₂ against a laboratory CO-Oximeter and ECG monitor. This variation equals plus or minus one standard deviation which encompasses 68% of the population. The saturation accuracy of the neonatal sensors were validated on adult male and female volunteers with light to dark skin pigmentation and 1% was added to account for the properties of fetal hemoglobin.

4. Masimo sensors have been validated for motion accuracy in human blood studies on healthy adult male and female volunteers with light to dark skin pigmentation in induced hypoxia studies while performing rubbing and tapping motions, at 2 to 4 Hz at an amplitude of 1 to 2 cm and a non-repetitive motion between 1 to 5 Hz at an amplitude of 2 to 3 cm in induced hypoxia studies in the range of 70-100% SpO₂ against a laboratory CO-Oximeter and ECG monitor. This variation equals plus or minus one standard deviation. Plus or minus one standard deviation encompasses 68% of the population.

5. Masimo SET technology has been validated for low perfusion accuracy in bench top testing against a Biotek Index 2 simulator and Masimo's simulator with signal strengths of greater than 0.02% and a % transmission of greater than 5% for saturations ranging from 70 to 100%. This variation equals plus or minus one standard deviation which encompasses 68% of the population.

6. Masimo sensors have been validated for pulse rate accuracy for the range of 25-240 bpm in bench top testing against a Biotek Index 2 simulator. This variation equals plus or minus one standard deviation which encompasses 68% of the population.

Specifications

Physical Specifications

Dimensions (HxWxD)	overall	80 cm x 38 cm x 38 cm
Total unit mass		18.0 kg
Alarms	High Priority Audible Alarm	5 pulse burst, followed by 0.5 second delay, followed by 5 pulse burst, followed by 3 second delay
	High Priority Audible Alarm (Power out)	330 Hz continuous tone
	Low Priority Audible Alarm	2 pulse burst, followed by 20 second delay
	High Priority Visual Alarm	Red flashing at 1.5 Hz
	Alarm Volume	>50 dBA at a distance of 1 meter
	Type	LED
Display	Display Update Rate	1 second
Ingress Protection	IPX1	This device is protected against harmful effects of dripping water per IEC 60529.
Air compressor	Internal	Integrated
Unit base	Mobile	4 caster wheels, 360° swivel with locks

Electrical Specifications

AC Power requirements	100-240V, 50-60 Hz
Power consumption	240 W maximum

Environmental Specifications

Operating	Ambient temperature	+19°C to +37°C
	Humidity	30% to 90% RH non condensing
	Atmospheric pressure	70-106kPa
Transport and storage	Ambient temperature	0°C to +50°C
	Humidity	5% to 90% RH non condensing
	Atmospheric pressure	70-106kPa

Specifications

Compliance

Electrical Safety	EN 60601-1:2006/A1:2013: Medical electrical equipment – Part 1 General requirements for basic safety and essential performance Type of Protection: Class 1 Degree of Protection - Patient Cable: Type BF, Defib Proof Applied Part
Electromagnetic Compatibility	EN 60601-1-2:2015: Medical electrical equipment – Part 1-2: General requirements for basic safety and essential performance – Collateral standard: Electromagnetic compatibility – Requirements and tests
Performance	EN 60601-1-6:2010 + A1:2015: Medical electrical equipment. General requirements for basic safety and essential performance - Collateral standard: Usability EN 60601-1-8:2007 + A1:2013 + A11:2017: Medical electrical equipment - Part 1-8: General requirements for basic safety and essential performance - Collateral Standard: General requirements, tests and guidance for alarm systems in medical electrical equipment and medical electrical systems EN ISO 14971:2012: Medical devices – Application of risk management to medical devices IEC 62304:2006 Medical device software – Software life cycle processes EN 1041:2008 + A1:2013: Information supplied by the manufacturer of medical device EN ISO 80601-2-61:2011: Medical electrical equipment – Part 1-2: General requirements for basic safety and essential performance of pulse oximeter equipment EN ISO 8185:2009: Respiratory tract humidifiers for medical use - Particular requirements for respiratory humidification systems EN ISO 10993-1:2009: Biological evaluation of medical devices – Part 1: Evaluation and testing within a risk management process EN ISO 15223-1:2016: Medical devices – Symbols to be used with medical device labels, labeling and information to be supplied – Part 1: General requirements
RoHS	2015/863/EU
WEEE	2012/19/EU

Explanation of Symbols



This statement provides important information or highlights information that may be easily overlooked.



This statement is a warning. Not following this statement could result in injury to the patient or operator, or damage to the device.



CE Marking with Notified Body Number.



Do not disassemble the device unless you are an MTTTS trained technician or have been instructed to by qualified personnel.



Refer to the user manual before operating this device.



Refer to the user manual before operating this device.



This device contains electronic parts. Do not dispose of it with normal waste. Dispose of it according to local guidelines for disposal of electronics. Dispose according to the WEEE directive in the European Union.



Medical device



Unique identification number



Website where a user can obtain additional information on the medical product



Name and address of European Authorized Representative.



Device manufacturer.



Date of manufacture.



Serial number.



Type and full rating of fuse.



Defibrillation-proof type BF applied part.



Liquid ingress protection - level 1 (dripping water).

Warranty Policy

General Terms

This MTTs Limited Warranty gives you, the customer, express limited warranty rights from MTTs, the manufacturer for the duration specified on the Warranty Card. Please refer to the MTTs Website for an extensive description of your limited warranty entitlements. In addition, you may also have other legal rights under applicable law or special written agreement with MTTs.

MTTS MAKES NO OTHER EXPRESS WARRANTY OR CONDITION WHETHER WRITTEN OR ORAL AND MTTS EXPRESSLY DISCLAIMS ALL WARRANTIES AND CONDITIONS NOT STATED IN THIS LIMITED WARRANTY. TO THE EXTENT ALLOWED BY LOCAL LAW OF JURISDICTIONS OUTSIDE VIETNAM, MTTS DISCLAIMS ALL IMPLIED WARRANTIES OR CONDITIONS, INCLUDING ANY IMPLIED WARRANTIES OF MERCHANTABILITY AND FITNESS FOR A PARTICULAR PURPOSE. FOR ALL TRANSACTIONS OCCURRING IN VIETNAM ANY IMPLIED WARRANTY OR CONDITION OF MERCHANTABILITY, SATISFACTORY QUALITY, OR FITNESS FOR A PARTICULAR PURPOSE IS LIMITED TO THE DURATION OF THE EXPRESS WARRANTY SET FORTH ABOVE. SOME COUNTRIES DO NOT ALLOW A LIMITATION ON HOW LONG AN IMPLIED WARRANTY LASTS OR THE EXCLUSION OR LIMITATION OF INCIDENTAL OR CONSEQUENTIAL DAMAGES FOR CONSUMER PRODUCTS. IN SUCH COUNTRIES, SOME EXCLUSIONS OR LIMITATIONS OF THIS LIMITED WARRANTY MAY NOT APPLY TO YOU. FOR CONSUMER TRANSACTION, THE LIMITED WARRANTY TERMS CONTAINED IN THIS STATEMENT, EXCEPT TO THE EXTENT LAWFULLY PERMITTED, DO NOT EXCLUDE, RESTRICT, OR MODIFY BUT ARE IN ADDITION TO THE MANDATORY STATUTORY RIGHTS APPLICABLE TO THE SALE OF THIS PRODUCT TO YOU.

This Limited Warranty is applicable in all countries and may be enforced in any country or region where MTTs or its authorized service providers offer warranty service for the same product model number (subject to the terms and conditions set forth in this Limited Warranty)

Under this Limited Warranty, products purchased in one country or region may be transferred to another country or region where MTTs or its authorized service providers offer warranty service for the same product model number. Warranty terms, service availability, and service response times may vary from country or region to country or region. Standard warranty service response time is subject to change due to local parts availability. If so, your MTTs authorized service provider can provide you with details. MTTs will not alter form, fit, or function of this MTTs product to make it operate in a country for which it was never intended to function for legal or regulatory reasons. MTTs is not responsible for any tariffs or duties that may be incurred in transferring the products.

MTTS guarantees that the product that you have purchased or leased from MTTs is free from defects in materials or workmanship under normal use during Limited Warranty Period. The Limited Warranty Period starts on the date of purchase or lease from MTTs, or from the date MTTs completes installation. Your dated sales or delivery receipt, showing the date of purchase of the product, is your proof of the purchase or lease date. You may be required to provide proof of purchase or lease as a condition of receiving warranty service. You are entitled to hardware warranty service according to the terms and conditions of this document if a repair to your MTTs product is required within the Limited Warranty Period.

Unless otherwise stated, and to the extent permitted by local law, new MTTs product may be manufactured using new materials and used materials equivalent to new in performance and reliability. MTTs may repair or replace MTTs products (a) with new or previously used products or parts equivalent to new in performance and reliability, or (b) with equivalent products to an original product that has been discontinued. Replacement parts are warranted to be free from defects in material or workmanship for ninety (90) days or, for the remainder of Limited Warranty Period of the MTTs product they are replacing or in which they are installed, whichever is longer.

Warranty Policy

MTTS will, at its sole discretion, repair or replace any components or product that manifests a defect in materials or workmanship during the Limited Warranty Period. All component parts removed under this Limited Warranty become the property of MTTs. In the unlikely event that your MTTs product has recurring failures, MTTs at its sole discretion, may elect to provide you with (a) a replacement unit selected by MTTs that is the same or equivalent to your MTTs product in performance or (b) to give you a refund of your purchase price or lease payments (less interests) instead of a replacement. This is your exclusive remedy for defective products.

Exclusions

MTTS DOES NOT WARRANT THAT THE OPERATION OF THIS PRODUCT WILL BE UNINTERRUPTED OR ERROR-FREE. MTTS IS NOT RESPONSIBLE FOR DAMAGE THAT OCCURS AS RESULT OF YOUR FAILURE TO FOLLOW THE INSTRUCTIONS INTENDED FOR THE PRODUCT.

This Limited Warranty does not apply to expendable or consumable parts and does not extend to any product from which the serial number has been removed or that has been damaged or rendered defective (a) as a result of accident, misuse, abuse, contamination, improper or inadequate maintenance or calibration (if required) or other external causes; (b) by operation outside the usage parameters stated in the user documentation shipped with the product; (c) by software, interfacing, parts or supplies not supplied by MTTs; (d) improper site preparation or maintenance; (e) virus infection; (f) loss or damage in transit; or (g) by modification or service by anyone other than (i) MTTs personnel, (ii) an MTTs authorized service provider, or (iii) your own installation of end-user replaceable MTTs or MTTs approved parts if available for your MTTs product in the servicing country or region.

Limitation of Liability

IF YOUR MTTs PRODUCT FAILS TO WORK AS WARRANTED ABOVE, THE MAXIMUM LIABILITY OF MTTs UNDER THIS LIMITED WARRANTY IS EXPRESSLY LIMITED TO THE LESSER OF THE PRICE YOU HAVE PAID FOR THE PRODUCT OR THE COSTS OF REPAIR OR REPLACEMENT OF ANY HARDWARE COMPONENTS THAT MALFUNCTION IN CONDITIONS OF NORMAL USE.

EXCEPT AS INDICATED ABOVE, IN NO EVENT WILL MTTs BE LIABLE FOR ANY DAMAGES CAUSED BY THE PRODUCT OR THE FAILURE OF THE PRODUCT TO PERFORM, INCLUDING ANY LOST PROFITS OR SAVINGS OR SPECIAL, INCIDENTAL, OR CONSEQUENTIAL DAMAGES. MTTs IS NOT LIABLE FOR ANY CLAIM MADE BY A THIRD PARTY OR MADE BY YOU FOR A THIRD PARTY.

THIS LIMITATION OF LIABILITY APPLIES WHETHER DAMAGES ARE SOUGHT, OR CLAIM MADE, UNDER THIS LIMITED WARRANTY OR AS A TORT CLAIM (INCLUDING NEGLIGENCE AND STRICT PRODUCT LIABILITY), A CONTRACT CLAIM, OR ANY OTHER CLAIM. THIS LIMITATION LIABILITY CANNOT BE WAIVED OR AMENDED BY ANY PERSON. THIS LIMITATION OF LIABILITY WILL BE EFFECTIVE EVEN IF YOU HAVE ADVISED MTTs OF THE POSSIBILITY OF ANY SUCH DAMAGES. THIS LIMITATION OF LIABILITY, HOWEVER, WILL NOT APPLY TO CLAIMS FOR PERSONAL INJURY.

THIS LIMITED WARRANTY GIVES YOU SPECIFIC LEGAL RIGHTS. YOU MAY ALSO HAVE OTHER RIGHTS THAT MAY VARY FROM COUNTRY TO COUNTRY. YOU ARE ADVISED TO CONSULT APPLICABLE COUNTRY LAWS FOR A FULL DETERMINATION OF YOUR RIGHTS.

Warranty Policy

Limited Warranty Period

The Limited Warranty Period for this MTTs product is a specified, fixed period commencing of the date of purchase and specified on the Warranty Card. The date on your sales receipt is the date of purchase unless MTTs or your reseller informs you otherwise in writing.

Customer Responsibilities

In order to avoid the risk of charges for issues not covered by your limited warranty (issues that are not due to defects in materials and workmanship on MTTs product), you will be asked to assist MTTs as follows:

- Verify configurations, load most recent firmware, install software patches, run MTTs diagnostics and utilities;
- Implement temporary procedures or workarounds provided by MTTs while MTTs works on permanent solution;
- Cooperate with MTTs in attempting to resolve the problem using online chat, email, or telephone. This may involve performing routine diagnostic procedures, installing additional software updates or patches;
- Perform additional tasks as defined within each type of warranty service provided by MTTs and any other actions that MTTs may reasonably request in order to best perform the warranty support

CUSTOMER IS RESPONSIBLE FOR DELIVERING THE PRODUCT (AND ALL COSTS INVOLVED) FROM HIS LOCATION TO THE MTTs AUTHORIZED SERVICE POINT.

Contacting MTTs

If your MTTs product fails during the Limited Warranty Period and the suggestions in the product documentation do not solve the problem, you can receive support by doing one of the following:

- Locate and contact your nearest MTTs service provider via MTTs website:
<http://www.mttts-asia.com/support/>
- Call the Technical Support Center:
+84 43 766 6521

Before calling MTTs or an MTTs authorized service provider please have the following information available:

- Product serial number and model name
- Applicable error messages
- Detailed questions



MEDICAL TECHNOLOGY TRANSFER AND SERVICES Co., LTD
House No. 26, Alley 41, An Duong Vuong Street, Tay Ho District, Hanoi City, Vietnam

Tel: +84 24 3766 6521
Fax: +84 24 3718 8050
Email: assistance@mtts-asia.com
www.mtts-asia.com



Logic s.r.l.
Via Antonio Pigafetta 1
34147 Trieste, Italy

